

Vakrangee
Kendra



BRONZE MODEL - WITHOUT ATM
DESIGN MANUAL
Version 01 | 2021

Content

Introduction	03
What is a Bronze kendra	04
Customer flow and zoning	05
Drawings	07-57
Placement of Equipment	58
Material palette and specifications	59
Furniture overview	61
Marketing elements and signage	63
Checkpoints	66
Covid - 19 Guidelines	68

Introduction

One Brand One Design

The design manual has been created to ensure that Kendra's design palette is consistent and expressed effectively across all the Kendra's at PAN India level.

The new design is a holistic concept which completely reboots the Vakrangee brand experience for customers.

Version 1: 2021 Bronze Model Without ATM Design Manual is MoHFW compliance for any Pandemic like situation. Health and Safety related regulations are followed in principle and utmost care is taken to safeguard the interest of Franchisee and General Public.

All parameters of ESG as defined by Vakrangee Ltd must be followed in Vakrangee Nextgen Kendra.

The design is refreshing and will appeal to a wide range of markets. A standardized design of Vakrangee Kendra in different regions is produced with a modular approach, and an unified enhancement. The concept strikes a balance between offering design elements and colour, along with offering quality, convenience and a high level of service.

The design is an open plan, making it extremely comfortable to identify service touch points with ease of movement around the space.

The Kendra environment promotes customers to experience a new way to interact with Vakrangee brand, leading to a smooth and pleasant journey in an inviting and friendly place.

Instructions for franchisee

Franchisee must follow the Brand Manual for placement of signage's, marketing, branding and advertisement materials inside and outside the store. Company has the right to change the Artwork/contents as and when required. Franchisee cannot display any additional branding material inside the Kendra unless and until approved by the company. Franchisee has no right to change/alter/delete/add any Artwork and Text matters in the Signage and Branding without written approval from the company. Maintenance of Signage's and Branding is in the scope of the Franchisee and any expenses incurred to maintain or repair any damage/defacing etc. will be in the scope of the Franchisee.

Bronze kendra Without ATM

Vakrangee Kendra offers a broad spectrum of services across different sectors to offer a “One Stop Shop” solution for its customers

Minimum carpet area for a Bronze kendra: 65 sq.ft

Minimum components: One counter

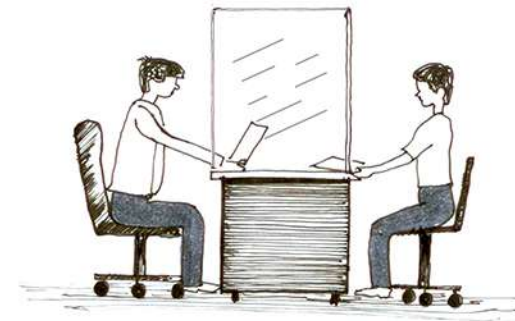
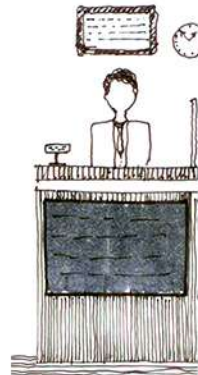

Operator 1 - Banking & Other Services Counter

- Lead generation/Documentation for loans
- Credit cards lead generation and documentation
- Social security schemes such as Atal Pension Yojana, Pradhan Mantri Jeevan Jyoti Yojana, Suraksha Bima Yojana
- Account opening, cash withdrawal & deposits, fund and money transfer, IMPS
- E-Commerce services
- E-Governance services
- Insurance services
- Financial and other services
- Logistics services
- Telemedicine Services

customer flow and zoning

04

Customer flow and zoning

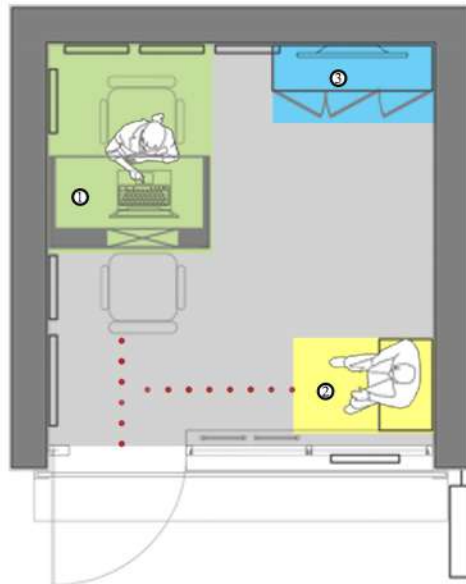
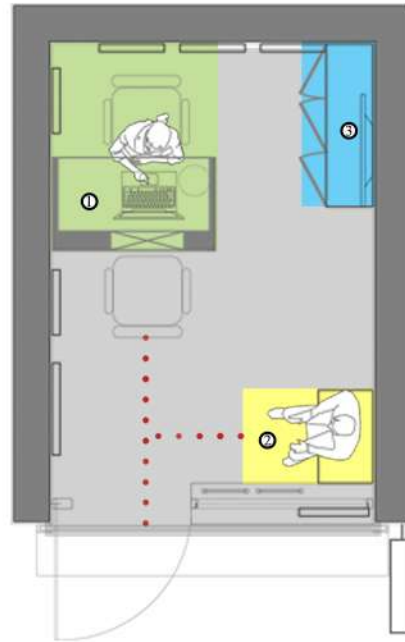
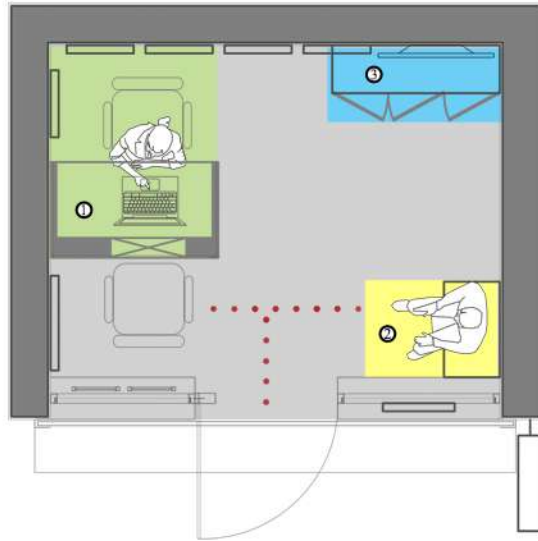

With customer at the core, different zones are created to standardise Kendra layouts.

A Kendra is divided into four main zones :

Zone 1 - Sales/counter

Zone 2 - Waiting Area/Customer Area

Zone 3 - Non Sales Area

 Zone 1 : Sales zone should cover approximate 25% of total floor space. This includes counter area and back storage area

 Zone 2 : Waiting Area/Customer Area should cover 30% of total floor space. This includes waiting bench, water dispenser and circulation area for the customer.

 Zone 3 : Non-sales area should cover approximate 15% of total floor space. This only includes storage room area.

 Customer flow 30%

drawings

05

Format Rectangular Horizontal

drawings

05.1

List of content

- General arrangement plan
- Kendra views
- Civil line-out
- Flooring layout
- Furniture setting out
- Paneling and wall finishes layout
- RCP & Elec. power layout
- Signage layout
- Internal elevations

Drawings | Rectangular horizontal format - General arrangement plan

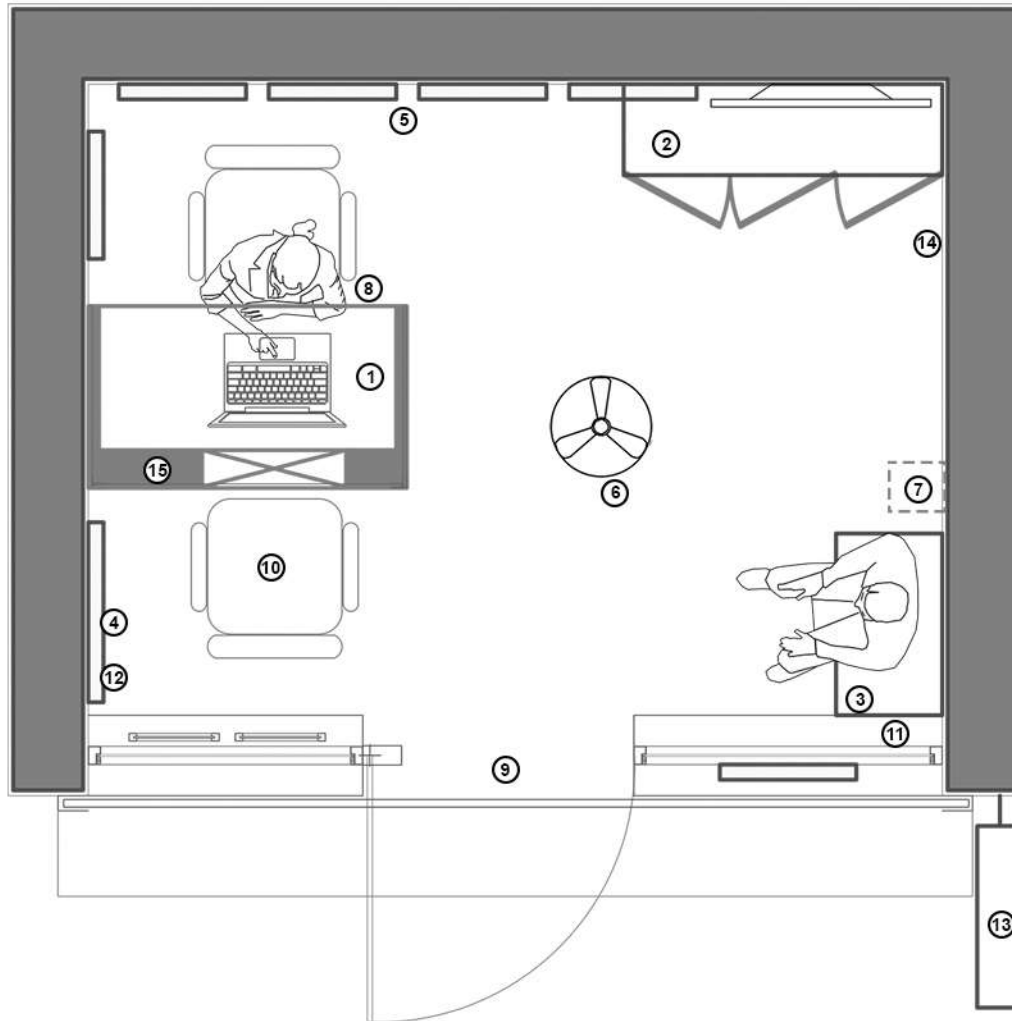

FURNITURE & EQUIPMENTS PLACEMENT (To be done by Franchisee)

Sr.No.	Items	Qty.
1	Bank & Other Services Counter	1
2	Storage Cabinet	1
3	Waiting Bench	1 (Preferable)
4	Leaflet Holder	1
5	Air Cooler / Air Conditioner	If Required
6	Fan	1
7	Water Dispenser	Preferable
8	Dustbin (Steel, Foot operated)	1
9	Doormat	1
10	Chairs	2
11	Fire Extinguisher	1
12	Soft Board	1
13	Lollipop Signage	1
14	Franchisee Certificate Frame	1
15	Sanitizing Station	As per requirment

01
XGA-0101 01 GENERAL ARRANGEMENT PLAN

Renders | Rectangular horizontal format - Top View

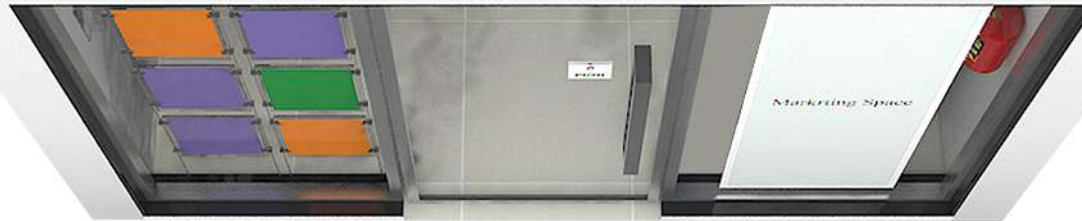

Renders | Rectangular horizontal format - Front View

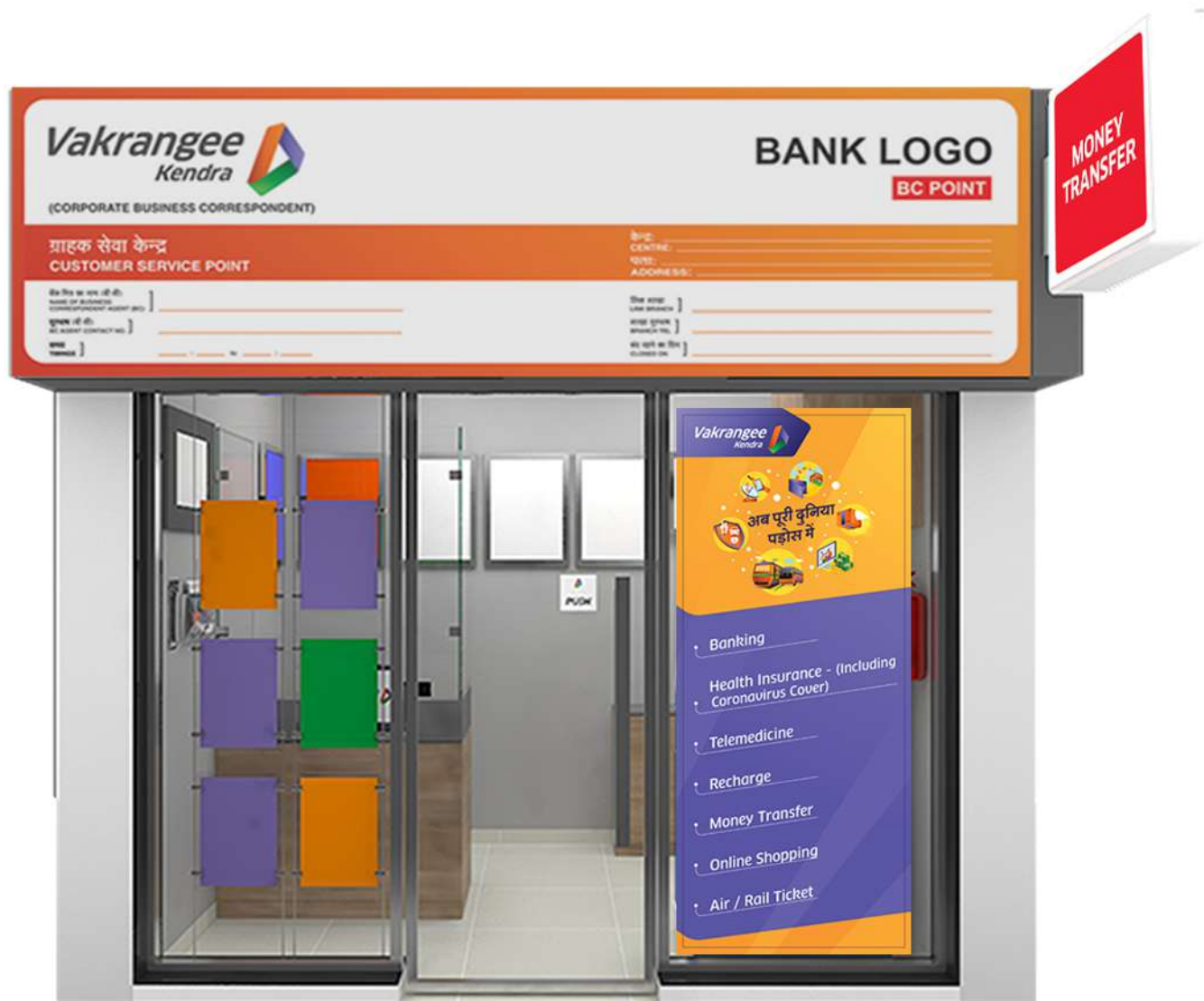

* 3D renders are for reference only. Please refer drawings for detailed specifications

Drawings | Rectangular horizontal format - Civil lineout 1/2

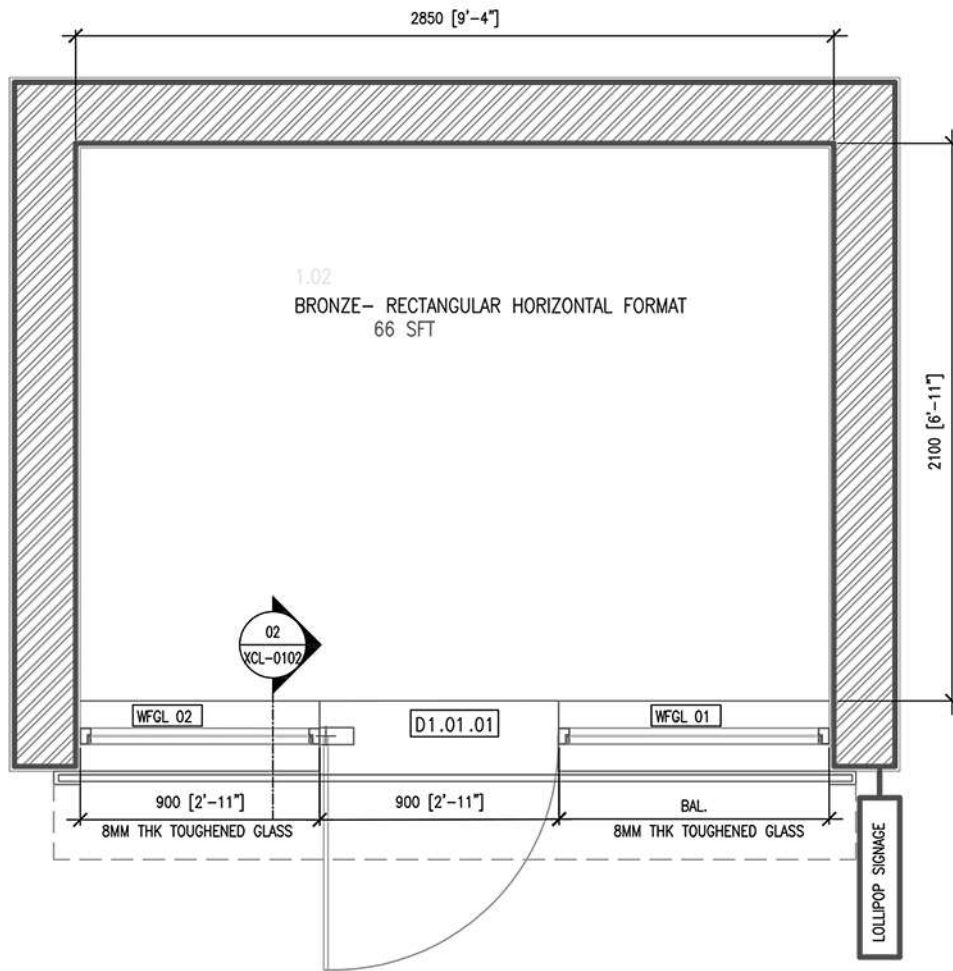

FIXED GLAZING SPECIFICATIONS

STRUCTURAL OPENING (UNFINISH TO UNFINISH)	SILL FROM FFL (IN MM)	LINTEL FROM FFL (IN MM)	WIDTH (IN MM)	HEIGHT (IN MM)	NOS.
WFGL 01	00	2150	AS PER SITE	AS PER SITE	1
WFGL 02	00	2150			1

DOOR SPECIFICATIONS

STRUCTURAL OPENING (UNFINISH TO UNFINISH)	WIDTH (IN MM)	HEIGHT (IN MM)
SERVICE AREA		
D1.01.01	900	2150

- DOOR HT. IS GIVEN CONSIDERING 50MM SCREED AND FLOOR TILE.
- ALL DOOR FINISHED HEIGHT TO BE 2100MM

01 XCL-0101 1:20 CIVIL LINE-OUT

Drawings | Rectangular horizontal format - Civil lineout 2/2

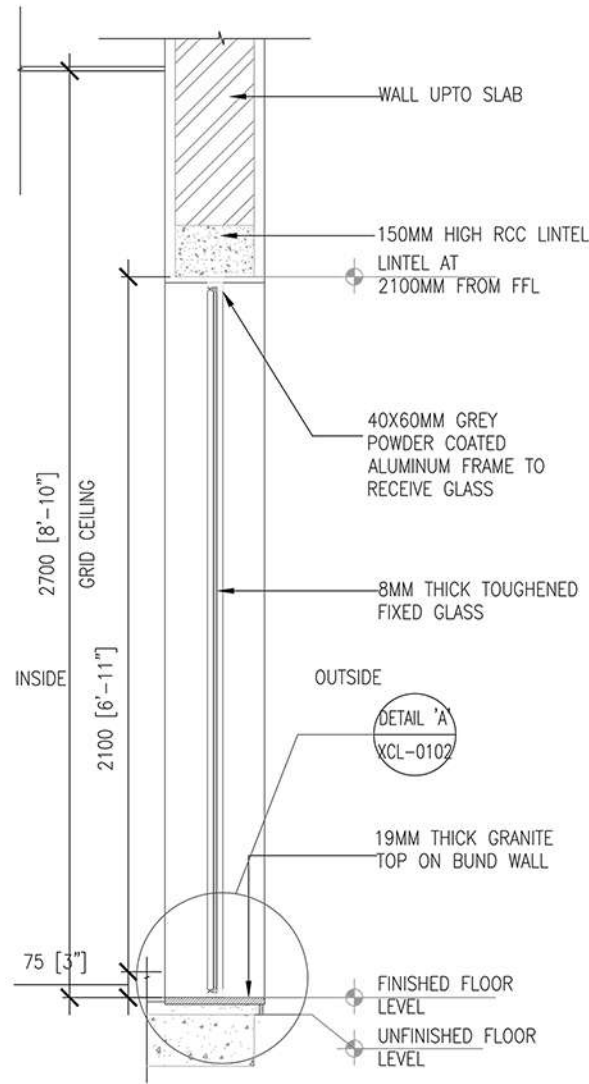

02 1:20 FIXED GLAZING SECTION-OPT-01
XCL-0102

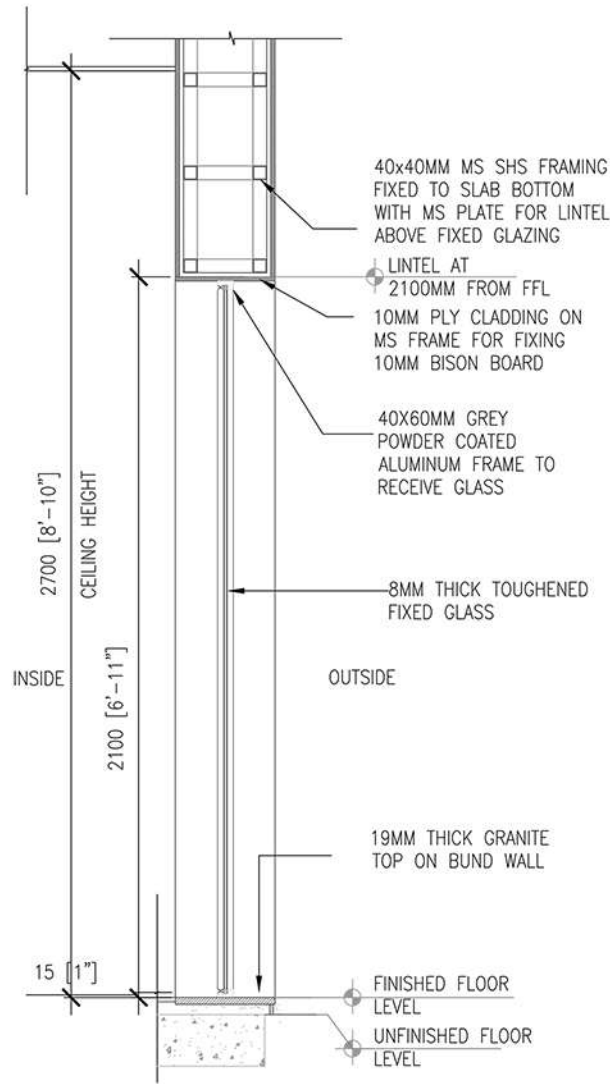



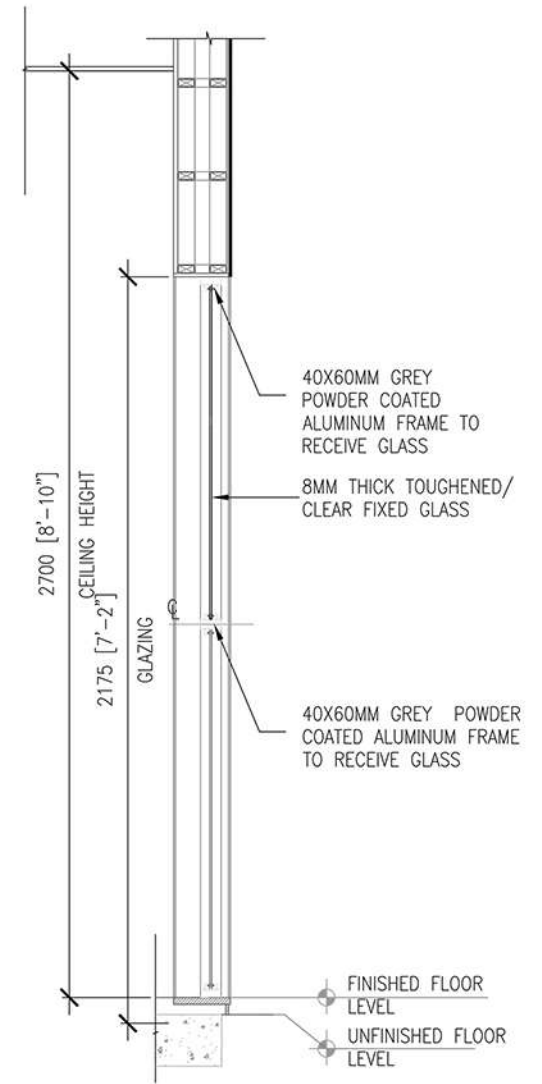

03 1:20 FIXED GLAZING SECTION-OPT-02
XCL-0102

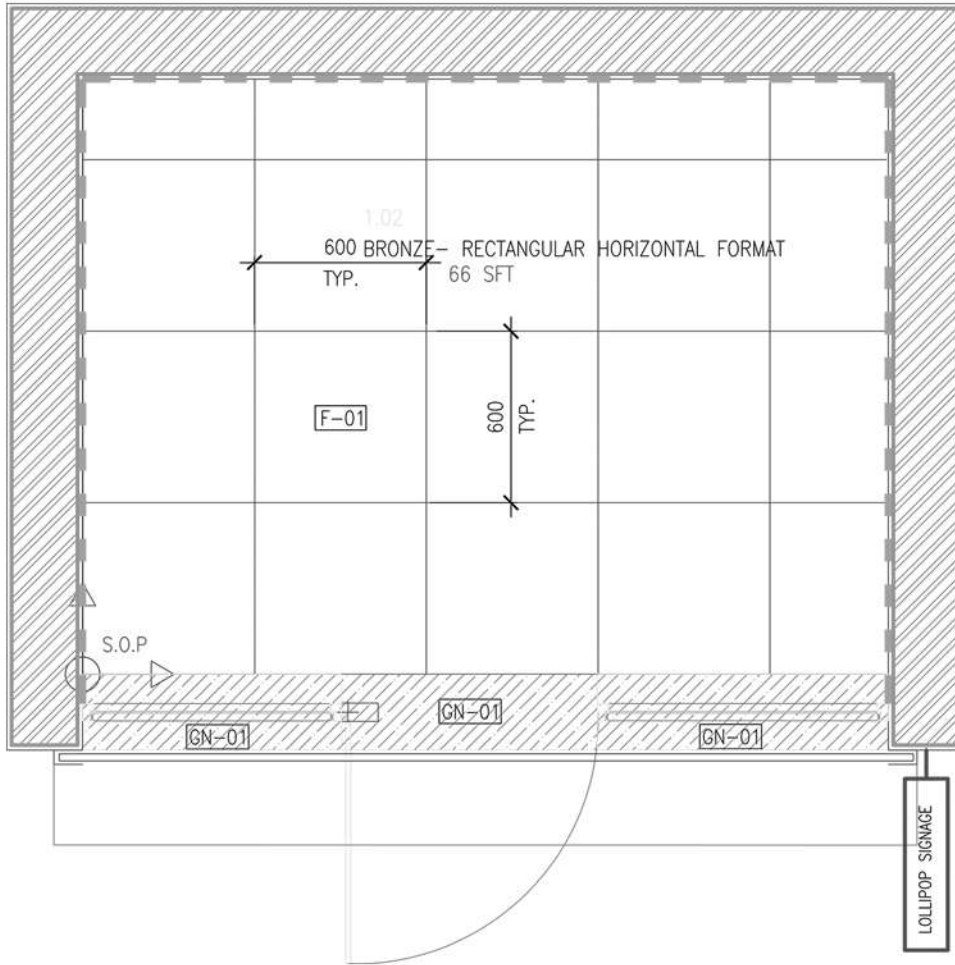

04 1:20 FIXED GLAZING SECTION-OPT-03
XCL-0102

Drawings | Rectangular horizontal format - Flooring layout 1/2





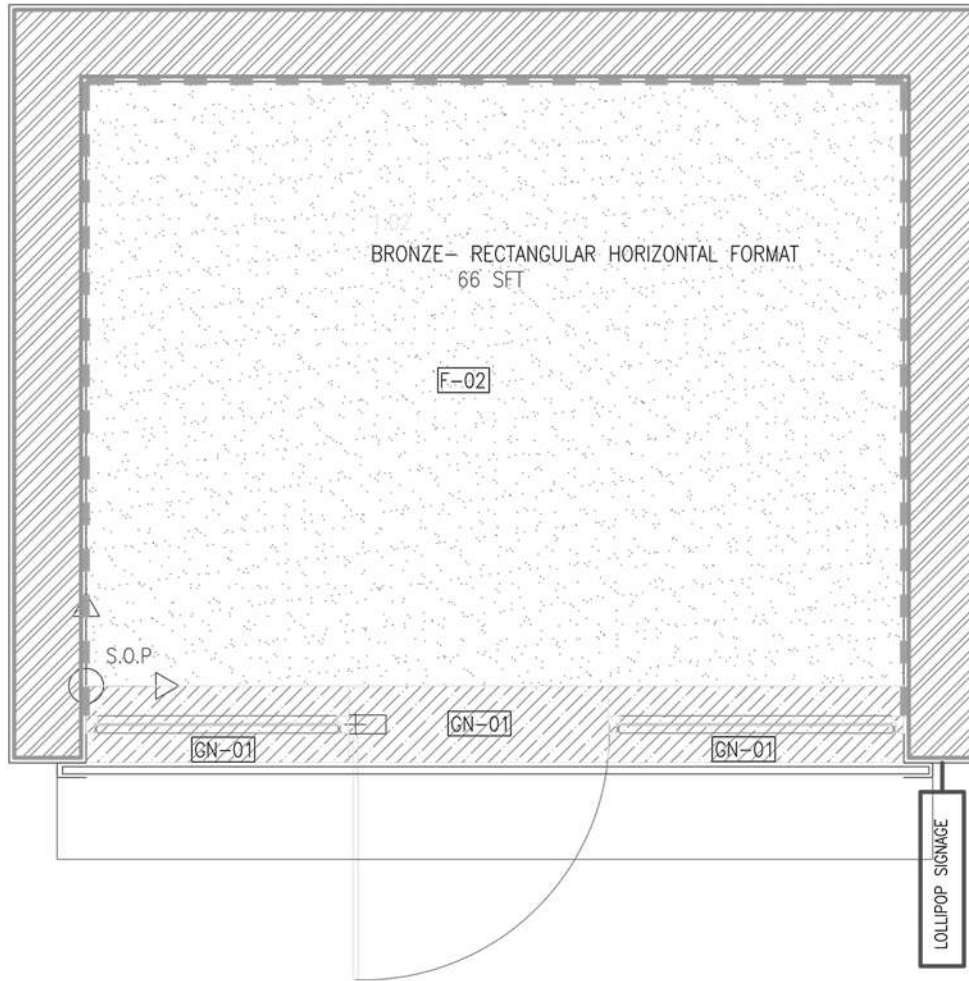

LEGEND		
SYMBOL	SPECIFICATION	MAKE
	F01 ESCARA LIGHT GREY (600X600)	SOMANY CERAMICS
	F02 VINYL FLOORING- ROLL FORM GENTLE GREY (K822-001)	ARMSTORNG
	GN1 GRANITE	
	SK-01 75MM HIGH SKIRTING SAME AS FLOOR TILES (FOR VINYL FLOORING AND TILES FLOORING)	

01 1:20 FLOORING LAYOUT
XFL-0101

Drawings | Rectangular horizontal format - Flooring layout 2/2



LEGEND		
SYMBOL	SPECIFICATION	MAKE
	F01 ESCARA LIGHT GREY (600X600)	SOMANY CERAMICS
	F02 VINYL FLOORING- ROLL FORM GENTLE GREY (K822-001)	ARMSTORNG
	GN1 GRANITE	
	SK-01 75MM HIGH SKIRTING SAME AS FLOOR TILES (FOR VINYL FLOORING AND TILES FLOORING)	

01
XFL-0102 1:20 FLOORING LAYOUT

Drawings | Rectangular horizontal format - Furniture setting out

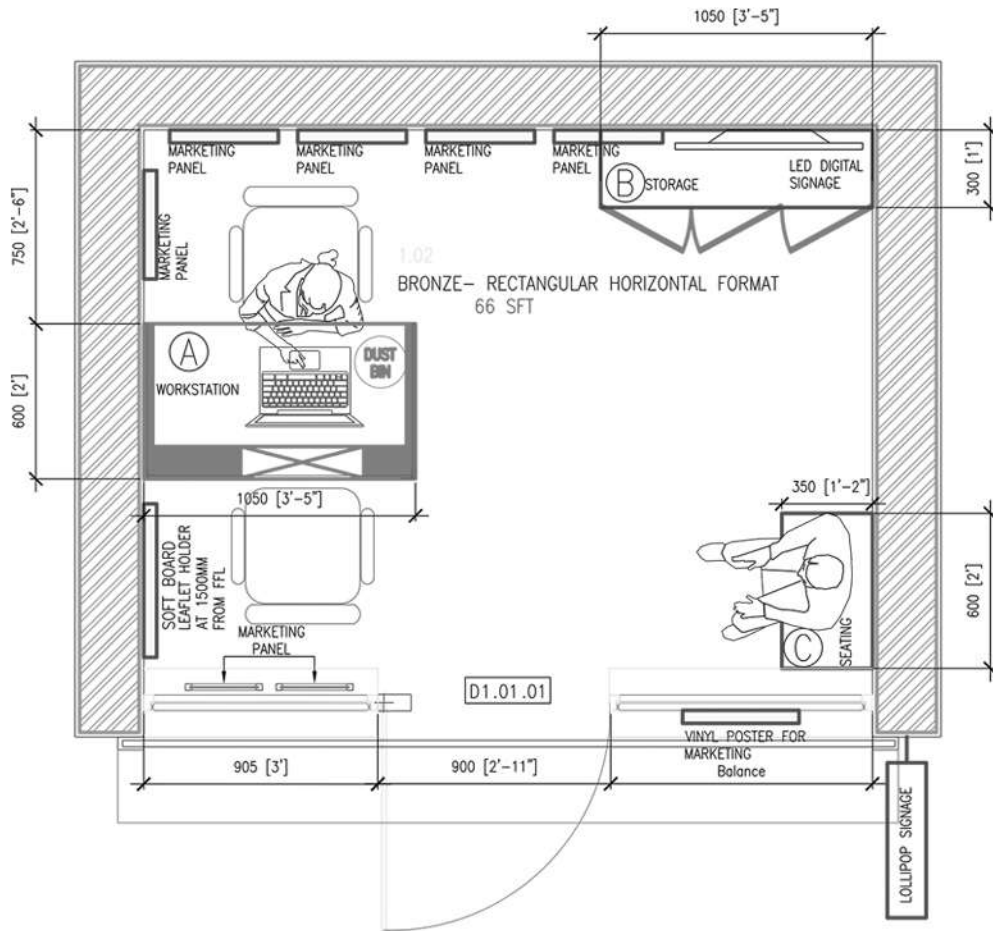



SR.NO.	CODE	DESCRIPTION	DIMENSION	FIXING	NOTES
1	(A)	MODULAR WORKSTATION	1050(L)X600(W)X 925(H)MM	LOOSE	WORKSTATION FINISH IN APPROVED LAMINATE GREENLAM, NORDIC WALNUT (5333) AND SMOG (269).
2	(B)	STORAGE CABINET	1050(L)X300(W)X 750(H)MM	LOOSE	MODULAR STORAGE CABINET FINISHED IN GREENLAM, NORDIC WALNUT (5333) & SMOG (269)
3	(C)	WAITING BENCH	600(L)X350(W)X 450(H)MM	LOOSE	MODULAR WAITING BENCH FINISHED IN GREENLAM NORDIC WALNUT (5333)

NOTE : PROVISION OF WAITING BENCH IS PREFERABLE

01 XFS-0101 1:20 FURNITURE SETTING OUT

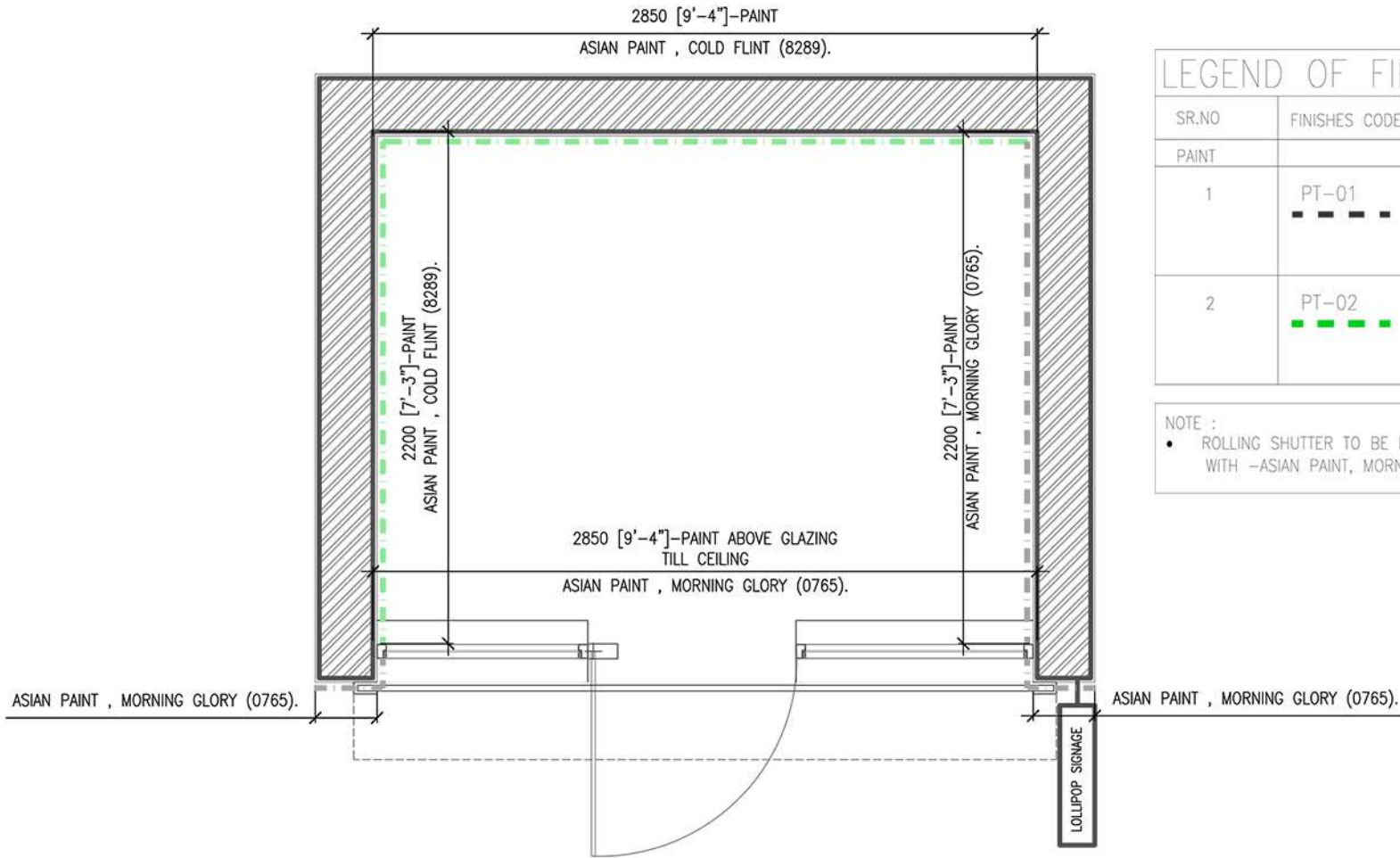
Drawings | Rectangular horizontal format - Paneling and wall finishes layout



LEGEND OF FINISHES			
SR.NO	FINISHES CODE	DESCRIPTION	
PAINT			
1	PT-01 - - - -	ASIAN PLASTIC PAINT , MORNING GLORY (0765).	
2	PT-02 - - - -	ASIAN PLASTIC PAINT , COLD FLINT (8289).	

NOTE :

- ROLLING SHUTTER TO BE FINISHED WITH SYNTHETIC ENAMEL PAINT TO MATCH WITH -ASIAN PAINT, MORNING GLORY (0765)

01 1:20 PANELLING LAYOUT
XPL-0101

Drawings | Rectangular horizontal format - RCP & Elec. power layout

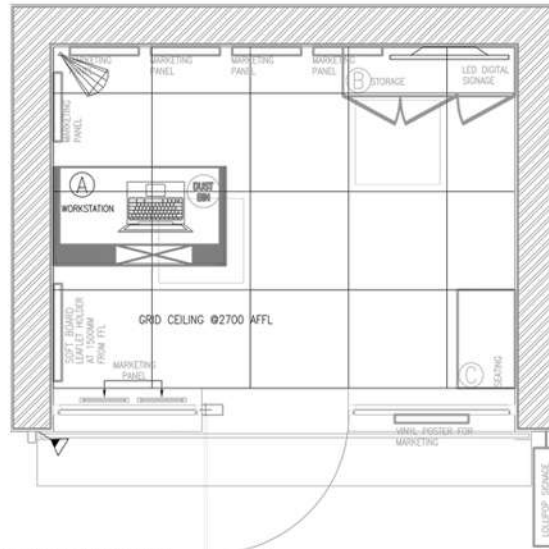

01 NTS: REFLECTED CEILING PLAN
XRC-0101 OPTION 1 WITH GRID CEILING

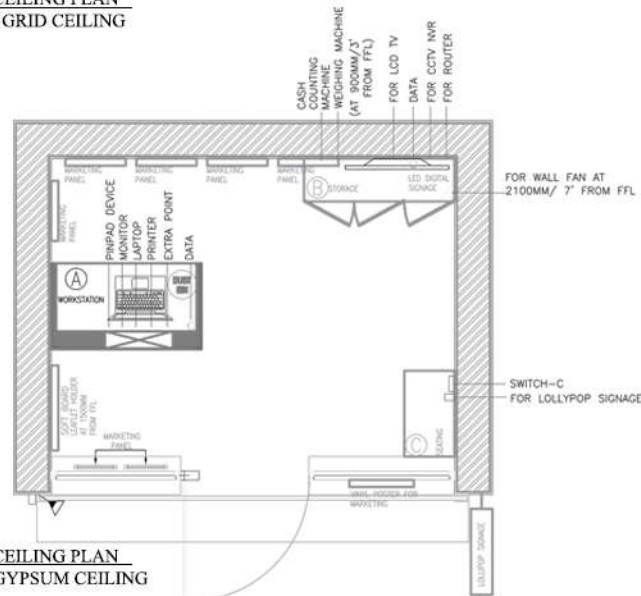

01 NTS: REFLECTED CEILING PLAN
XRC-0101 OPTION 2 WITH GYPSUM CEILING

NOTE : • PLEASE KEEP EXTRA CABLE LENGTH OF 2MTR AT THE CCTV CAMERA LOCATION FOR SMOOTH INSTALLATION.
• THE CASH COUNTING MACHINE SHOULD BE VISIBLE IN CAMERA

CEILING FINISH LEGEND	
REF.	FINISHES
	062700 AFFL GRID CEILING WITH 600 X 600MM TILES REGULAR EDGE REGULAR COLOUR-WHITE ANTI-STAINING- FINE FISSURED

LIGHT FIXTURE LEGEND	
	AELP30K, 30W, 6000K WITH LED EDGO LED & PHILIPS DRIVER
	150 W LED -BRIGHT WHITE -FOCUS LIGHT ABOVE EXTERNAL- MAIN SIGNAGE
	18 W RECESSED LED LIGHT 150X150
	36 / 42XCEILING FAN @ 2700mm FFL HIGH SPEED/WHITE COLOR HAVELLS/BAJAJ/CROMPTON & GREAVES

ELECTRICAL LEGEND:

	2/3 PIN 6A SWITCH SOCKET ON RAW POWER
	3/3 PIN 16A SWITCH SOCKET ON RAW POWER
	2/3 PIN 16A SWITCH SOCKET EXTERNAL SIGNAGE
	DATA OUTLET (CAT 6)
	WALL FAN @ 2100mm/7' FFL IF REQUIRED
	CEILING FAN @ 2700mm FFL/HIGH SPEED/WHITE COLOR
	32A AC SWITCH @ 2100mm/7' FROM FFL AND AC AT 2400mm/8' FROM FFL
	AC UNIT AT 2400mm/8' FROM FFL
	SWITCH @ 1200mm/4' FROM FFL-ANCHOR ROMA ROMA CLASSIC/ ANCHOR PENTA MODULAR WHITE PLATES
	2 kg ABC FIRE EXTINGUISHER AT 900mm FFL
	CCTV CAMERA @ CEILING HT LVL

NOTES:

- LIGHT FITTING - LED LIGHT
- WORKSTATION - ALL POINTS BELOW TABLE TOP
- STORAGE CABINET - ALL ELECTRICAL POINTS TO BE AT 900MM
- GENSET/INVERTER TO BE PLACED AS PER SITE CONDITION.
- INCASE IF THERE IS NO STORAGE WITHIN THE SITE, DB AND INVERTER TO BE KEPT NEAR THE MAIN ENTRY.
- VOLTAGE PARAMETERS REQUIRED FOR NORMAL OPERATING OF ATM MACHINE
- AC VOLTAGE - 198V TO 257V WITH 50Hz FREQUENCY

SWITCH-A (AT 4' FROM FFL)	1. 2 WAY SWITCH FOR ONE LIGHT POINT 2. SWITCH FOR EXTERNAL SIGNAGE LIGHT
SWITCH-B (AT 4' FROM FFL)	1. 1 SWITCH FOR ALL LIGHT POINTS 2. 2 WAY SWITCH FOR ONE LIGHT POINT 3. SWITCHES FOR FANS 4. SWITCH FOR STORE ROOM LIGHT
SWITCH-C (AT 4' FROM FFL)	1. SWITCH LIGHT.

NOTE: BOTTOM OF SWITCHBOARD BELOW COUNTER -600MM/(2)

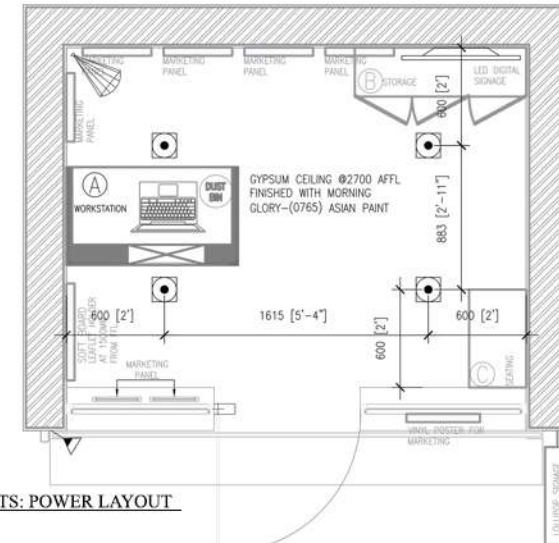

02 NTS: POWER LAYOUT
XRC-0101

Drawings | Rectangular horizontal format - Electrical SLD

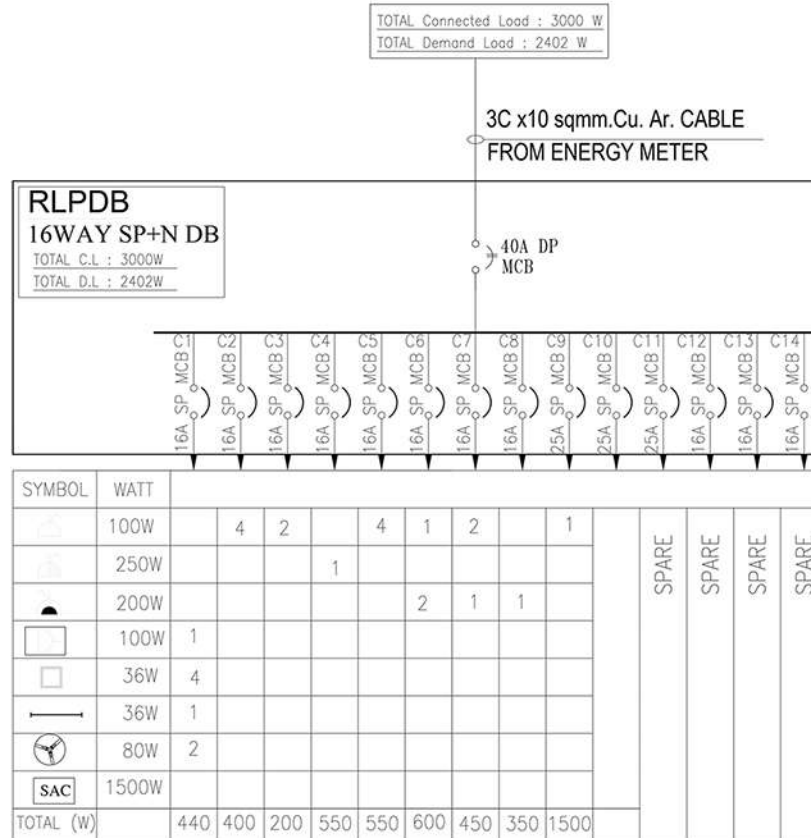

NOTES:

- APPROXIMATE REQUIRED LOAD FOR BRONZE WITHOUT ATM FORMAT -1600 W
- FINAL LOAD TO BE CALCULATED AS PER ACTUAL SITE REQUIREMENTS.
- INVERTER OR GEN-SET LOAD TO BE CALCULATED AS PER SITE REQUIREMENTS.
- FOR ALL POWER POINTS: 3CX2.5 SQMM FRLS FLEXIBLE COPPER CONDUCTOR CABLES.
- FOR SPLIT UNIT : 3CX4 SQMM FRLS FLEXIBLE COPPER CONDUCTOR CABLES.
- FOR ALL LIGHT & FAN CONNECTION: 3CX1.5 SQMM FRLS FLEXIBLE COPPER CONDUCTOR CABLES.
- FOR DATA AND TELEPHONE: 4 PAIR CAT 6 UTP WIRE.

Drawings | Rectangular horizontal format - Signage layout

* PLEASE REFER PAGE NO-64 FOR SIGNAGE DETAILS

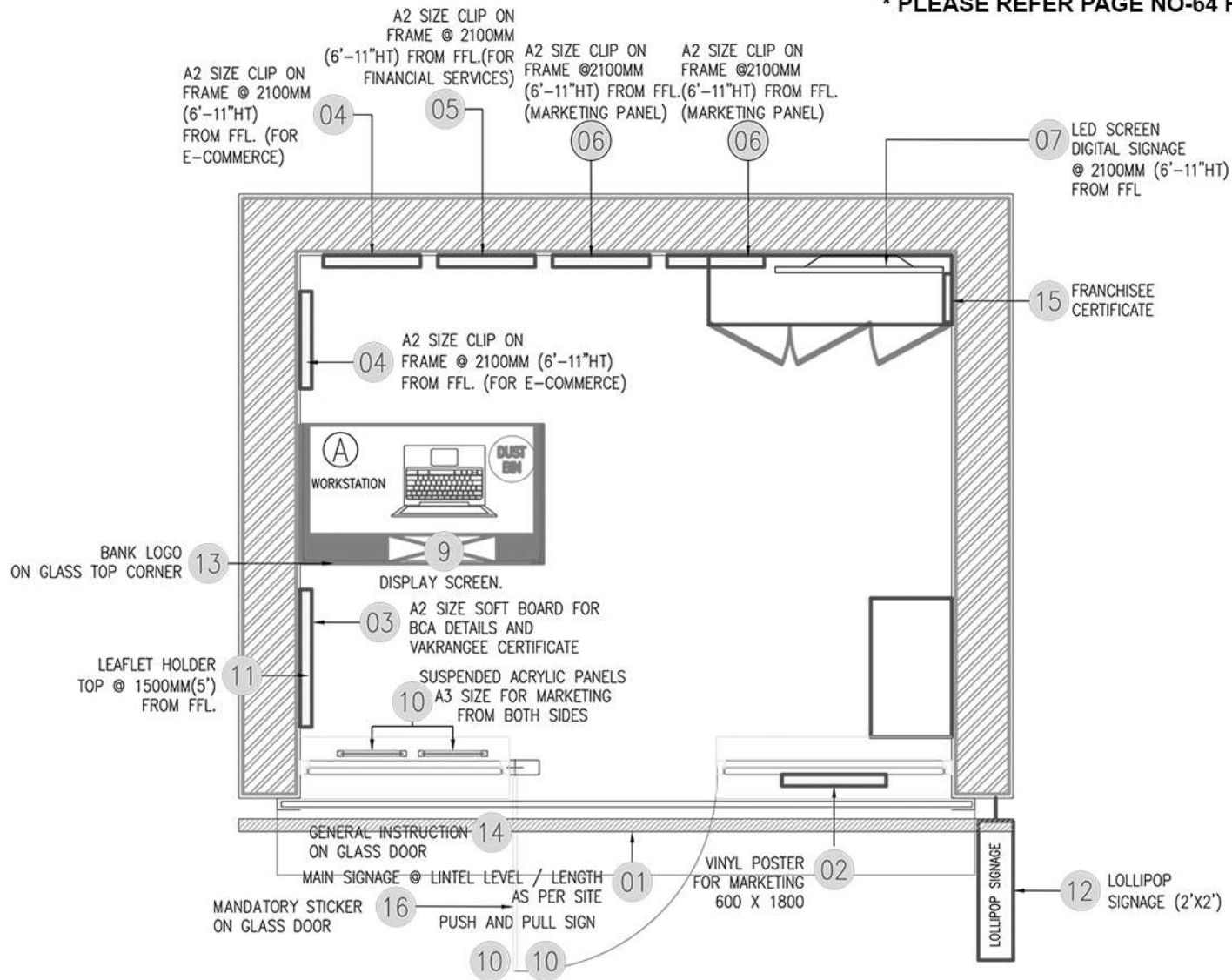

01 1:20 SIGNAGE LAYOUT
XSL-0101

Drawings | Rectangular horizontal format - Internal elevations

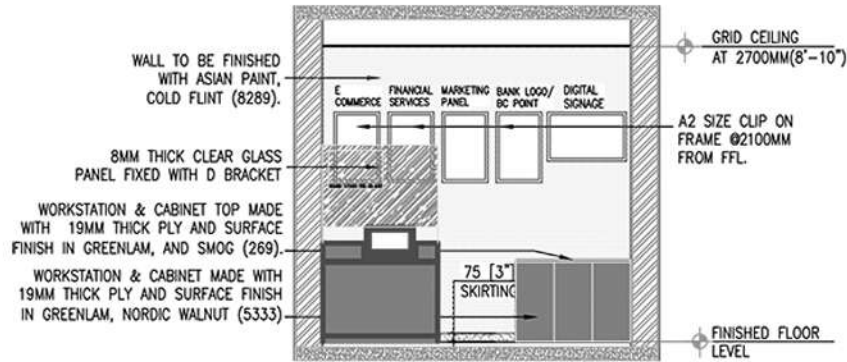

02 1:50 INTERNAL ELEVATION - 02
XIE-0101

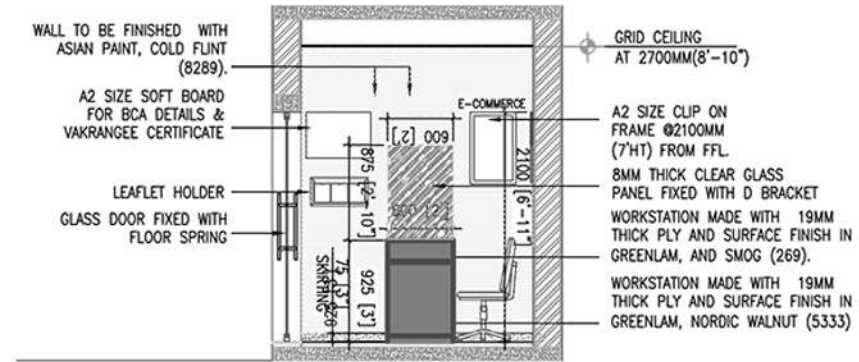

03 1:50 INTERNAL ELEVATION - 03
XIE-0101

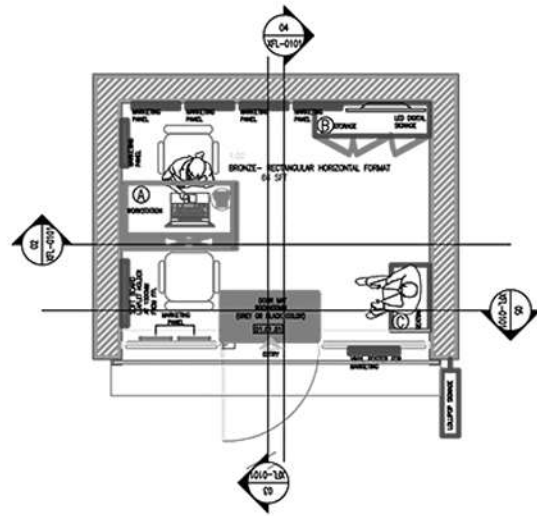

01 1:20 GENERAL ARRANGEMENT PLAN
XIE-0101

NOTE :

- IF 8 MM TOUGHENED GLASS IS NOT AVAILABLE, FRANCHISEE TO USE 12 MM CLEAR GLASS.
- IF GREY OR BLACK OR WHITE POWDER COATING IS NOT AVAILABLE, FRANCHISEE TO USE NATURAL ALUMINUM FINISH.

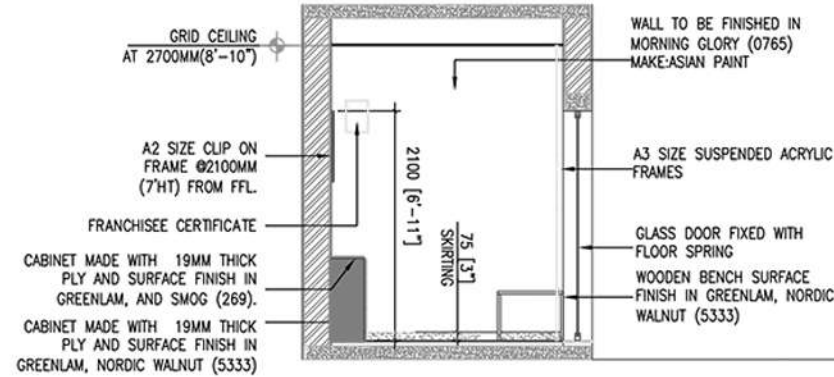

04 1:50 INTERNAL ELEVATION - 04
XIE-0101

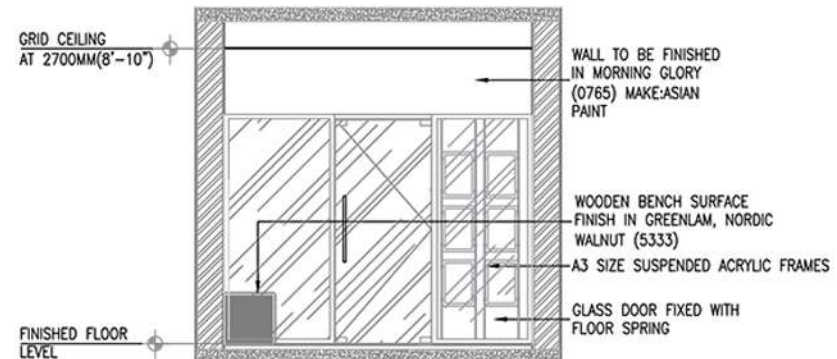

05 1:50 INTERNAL ELEVATION - 05
XIE-0101

Format Rectangular Vertical

drawings

05.2

List of content • General arrangement plan • Kendra views • Civil line-out • Flooring layout • Furniture setting out • Paneling and wall finishes layout • RCP & Elec. power layout • Signage layout • Internal elevations

Drawings | Rectangular vertical format - General arrangement plan

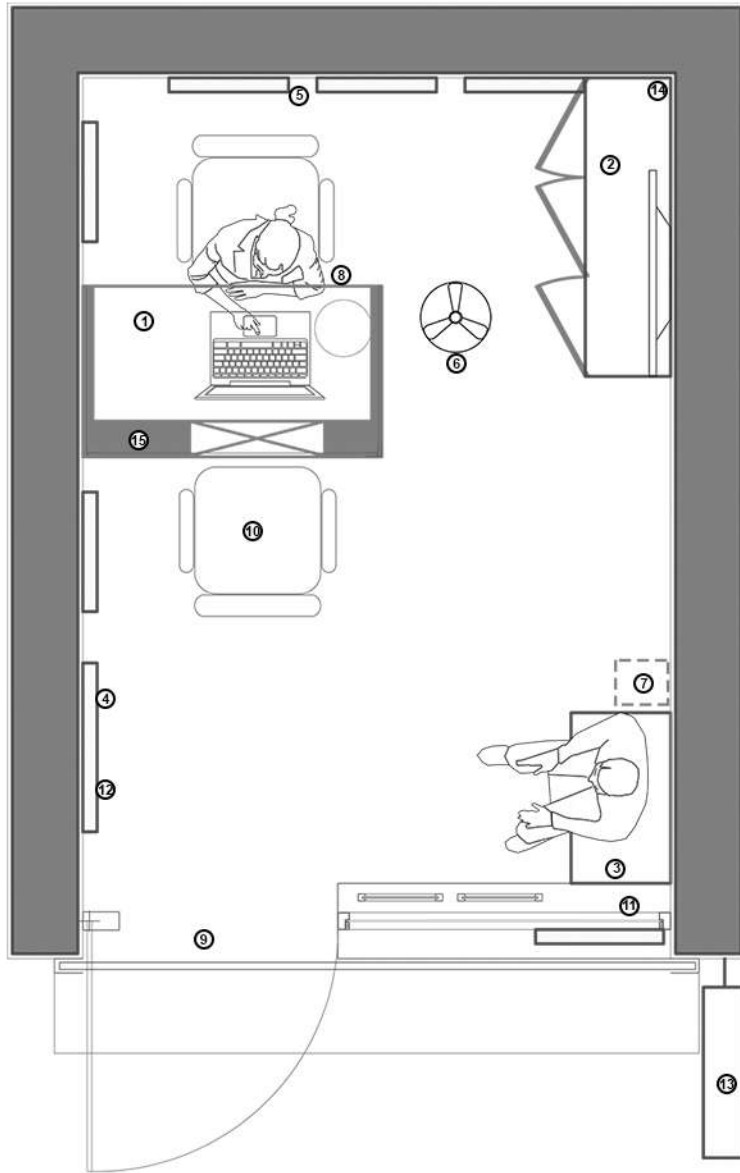

FURNITURE & EQUIPMENTS PLACEMENT (To be done by Franchisee)

Sr.No.	Items	Qty.
1	Bank & Other Services Counter	1
2	Storage Cabinet	1
3	Waiting Bench	1 (Preferable)
4	Leaflet Holder	1
5	Air Cooler / Air Conditioner	If Required
6	Fan	1
7	Water Dispenser	Preferable
8	Dustbin (Steel, Foot operated)	1
9	Doormat	1
10	Chairs	2
11	Fire Extinguisher	1
12	Soft Board	1
13	Lollipop Signage	1
14	Franchisee Certificate Frame	1
15	Sanitizing Station	As per requirement

01 NTS GENERAL ARRANGEMENT PLAN
XGA-0101

Renders | Rectangular vertical format - Top View

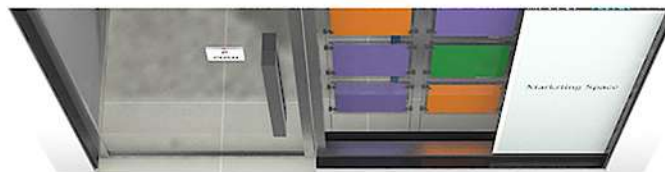

* 3D renders are for reference only. Please refer drawings for detailed specifications

Renders | Rectangular vertical format - Front View

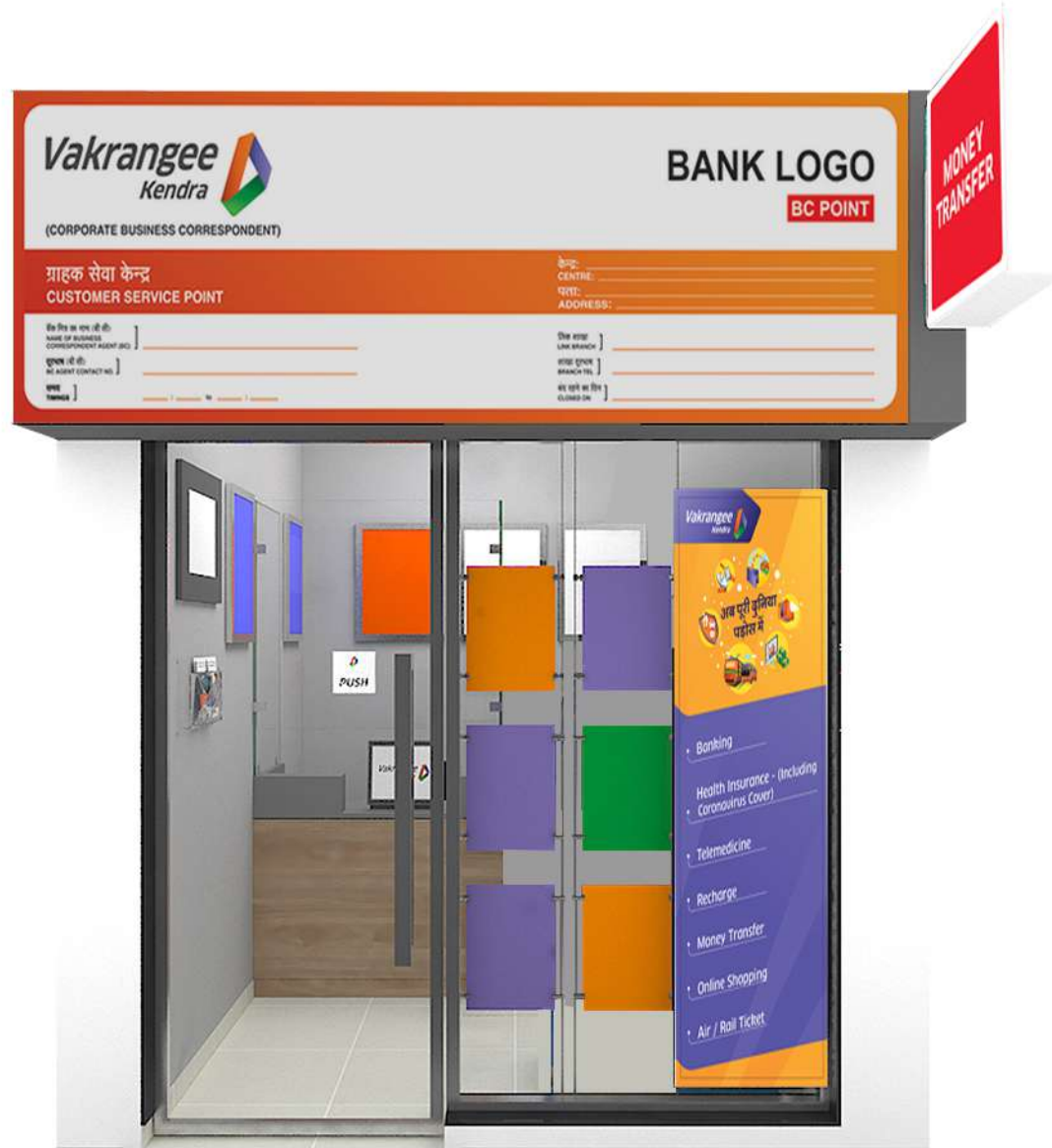

* 3D renders are for reference only. Please refer drawings for detailed specifications

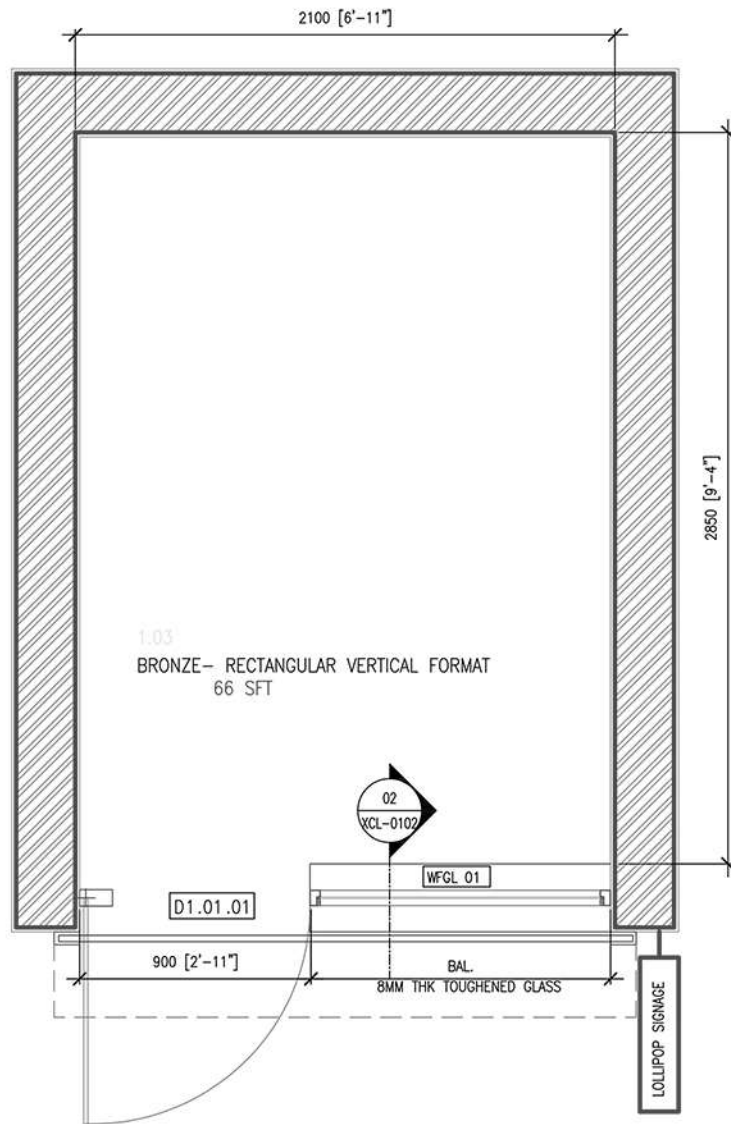

FIXED GLAZING SPECIFICATIONS

STRUCTURAL OPENING (UNFINISH TO UNFINISH)	SILL FROM FFL (IN MM)	LINTEL FROM FFL (IN MM)	WIDTH (IN MM)	HEIGHT (IN MM)	NOS.
WFGL 01	00	2150	AS PER SITE	AS PER SITE	1

DOOR SPECIFICATIONS

STRUCTURAL OPENING (UNFINISH TO UNFINISH)	WIDTH (IN MM)	HEIGHT (IN MM)
SERVICE AREA		
D1.01.01	900	2150

- DOOR HT. IS GIVEN CONSIDERING 50MM SCREED AND FLOOR TILE.
- ALL DOOR FINISHED HEIGHT TO BE 2100MM

01
XCL-0101 1:20 CIVIL LAYOUT

Drawings | Rectangular vertical format - Civil lineout 2/2

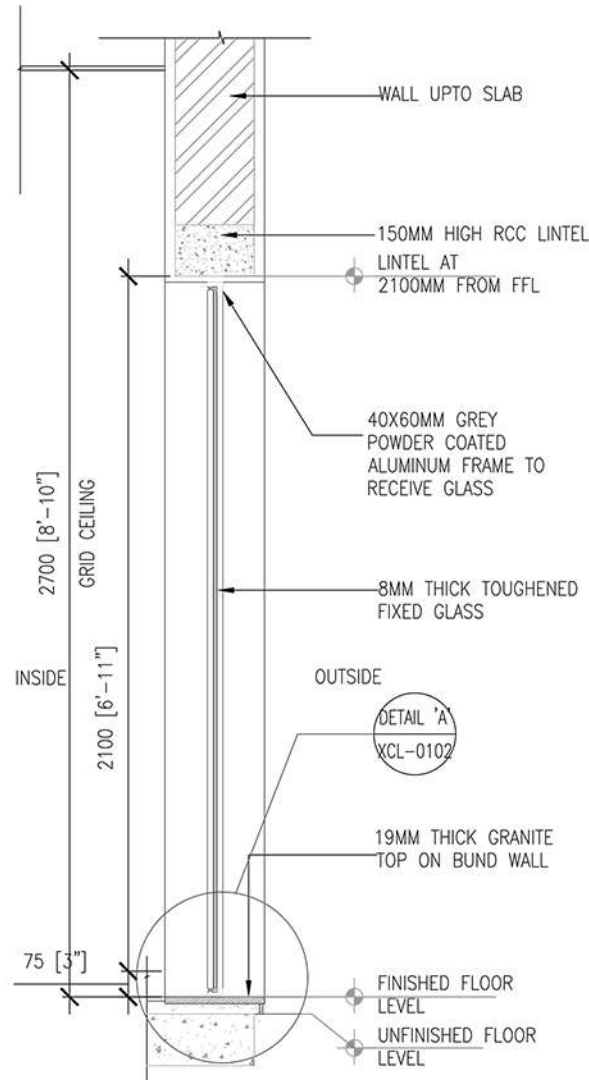

02 1:20 FIXED GLAZING SECTION-OPT-01
XCL-0102

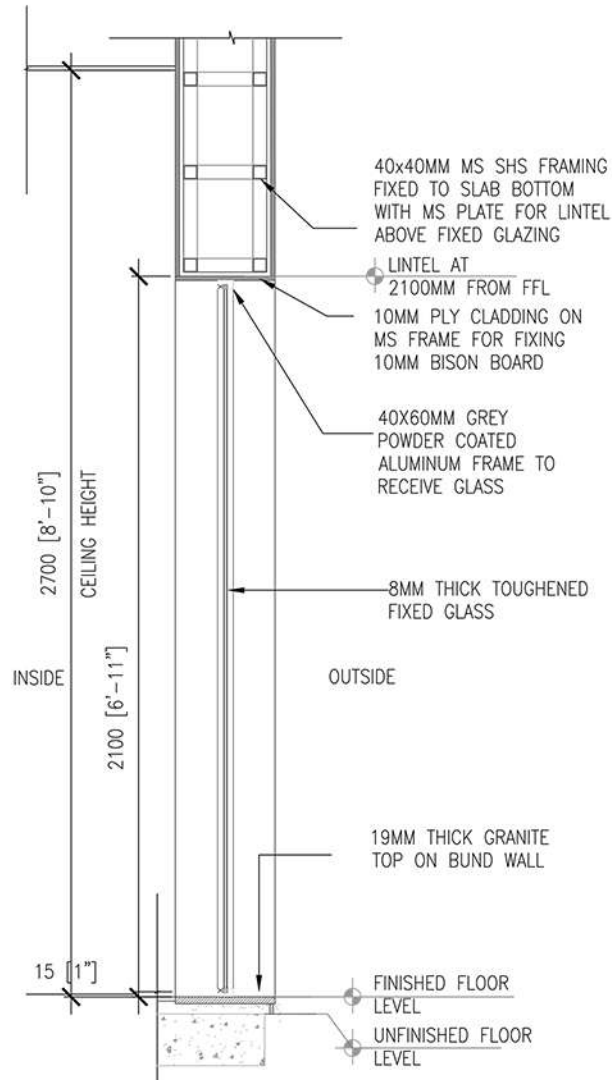



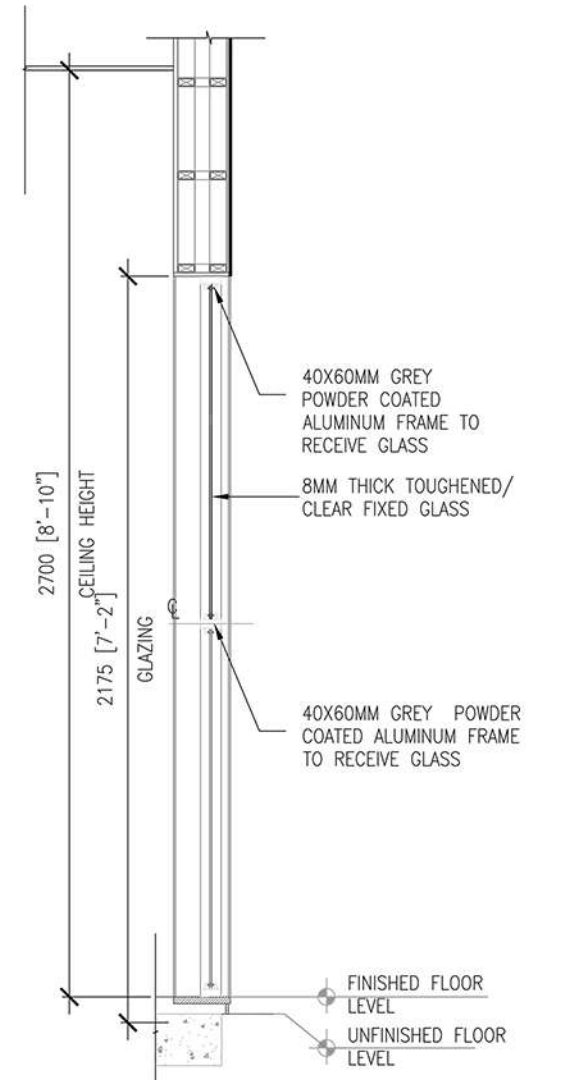

03 1:20 FIXED GLAZING SECTION-OPT-02
XCL-0102

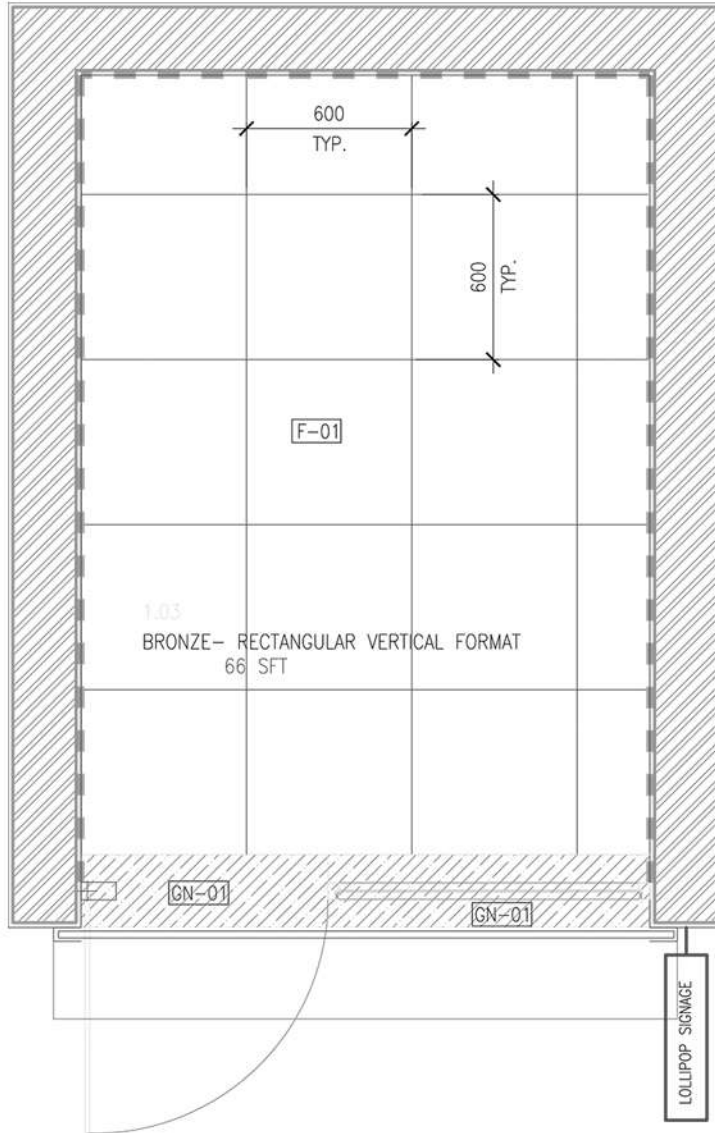

04 1:20 FIXED GLAZING SECTION-OPT-03
XCL-0102

Drawings | Rectangular vertical format - Flooring layout 1/2





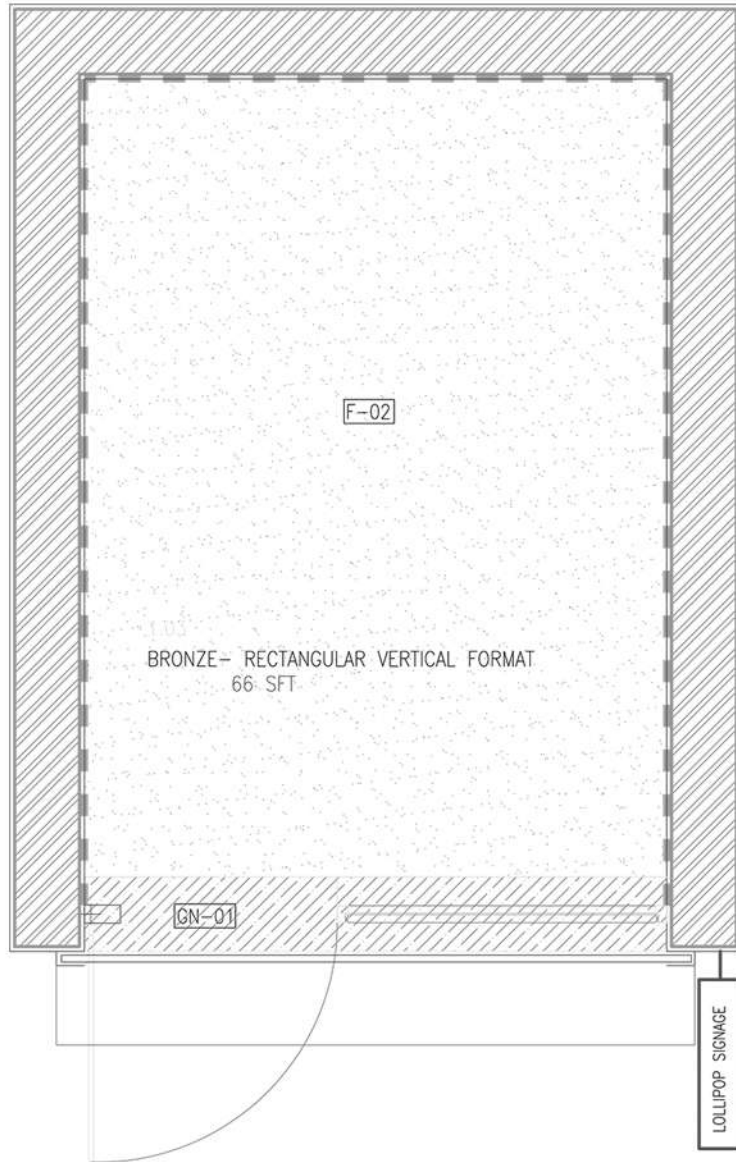

LEGEND		
SYMBOL	SPECIFICATION	MAKE
	F01 ESCARA LIGHT GREY (600X600)	SOMANY CERAMICS
	F02 VINYL FLOORING- ROLL FORM GENTLE GREY (K822-001)	ARMSTORNG
	GN1 GRANITE	
	SK-01 75MM HIGH SKIRTING SAME AS FLOOR TILES (FOR VINYL FLOORING AND TILES FLOORING)	

01 1:20 FLOORING LAYOUT
XFL-0101

Drawings | Rectangular vertical format - Flooring layout 2/2



LEGEND		
SYMBOL	SPECIFICATION	MAKE
	F01 ESCARA LIGHT GREY (600X600)	SOMANY CERAMICS
	F02 VINYL FLOORING- ROLL FORM GENTLE GREY (K822-001)	ARMSTORNG
	GN1 GRANITE	
	SK-01 75MM HIGH SKIRTING SAME AS FLOOR TILES (FOR VINYL FLOORING AND TILES FLOORING)	

01 1:20 FLOORING LAYOUT
XFL-0102

Drawings | Rectangular vertical format - Furniture setting out

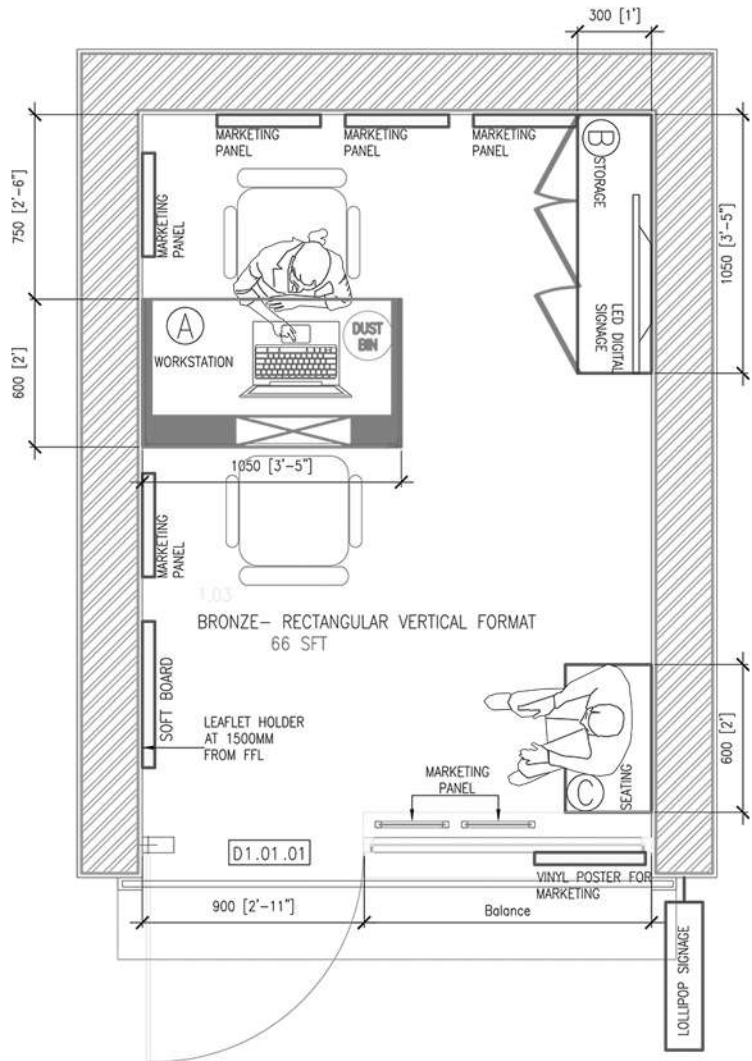

SR.NO.	CODE	DESCRIPTION	DIMENSION	FIXING	NOTES
1	(A)	MODULAR WORKSTATION	1050(L)X600(W)X 925(H)MM	LOOSE	WORKSTATION FINISH IN APPROVED LAMINATE GREENLAM, NORDIC WALNUT (5333) AND SMOG (269).
2	(B)	STORAGE CABINET	1050(L)X300(W)X 750(H)MM	LOOSE	MODULAR STORAGE CABINET FINISHED IN GREENLAM, NORDIC WALNUT (5333) & SMOG (269)
3	(C)	WAITING BENCH	600(L)X350(W)X 450(H)MM	LOOSE	MODULAR WAITING BENCH FINISHED IN GREENLAM NORDIC WALNUT (5333)

NOTE : PROVISION OF WAITING BENCH IS PREFERABLE.

01 1:20 FURNITURE SETTING OUT
XFS-0101

Drawings | Rectangular vertical format - Paneling and wall finishes layout

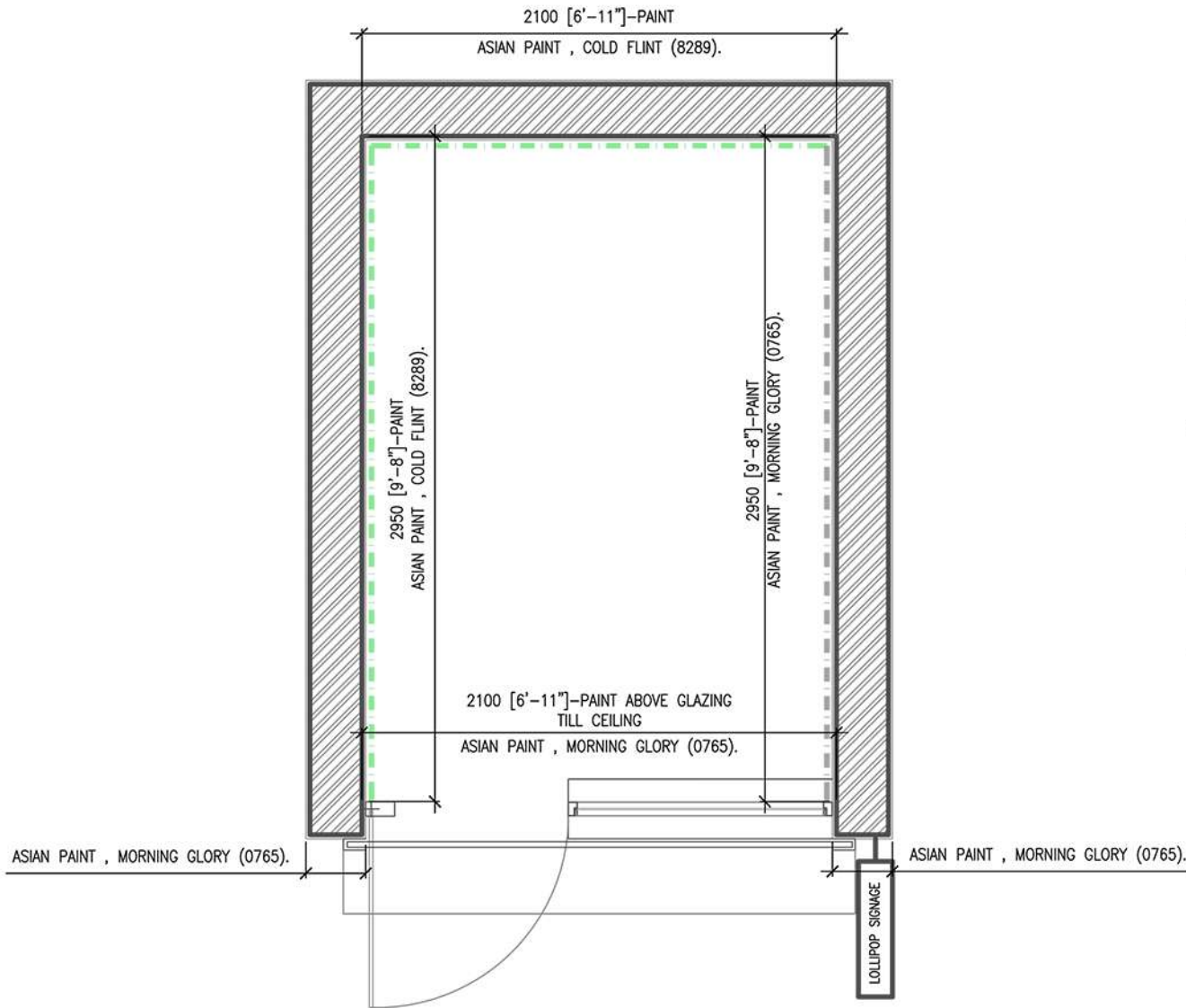

LEGEND OF FINISHES			
SR.NO	FINISHES CODE	DESCRIPTION	
PAINT			
1	PT-01 - - - - -	ASIAN PAINT, MORNING GLORY (0765).	
2	PT-02 - - - - -	ASIAN PAINT, COLD FLINT (8289).	

NOTE :

- ROLLING SHUTTER TO BE FINISHED WITH SYNTHETIC ENAMEL PAINT TO MATCH WITH -ASIAN PAINT, MORNING GLORY (0765)

01
XGA-0101 1:20 PANELLING LAYOUT

Drawings | Rectangular vertical format - RCP & Elec. power layout 1/2

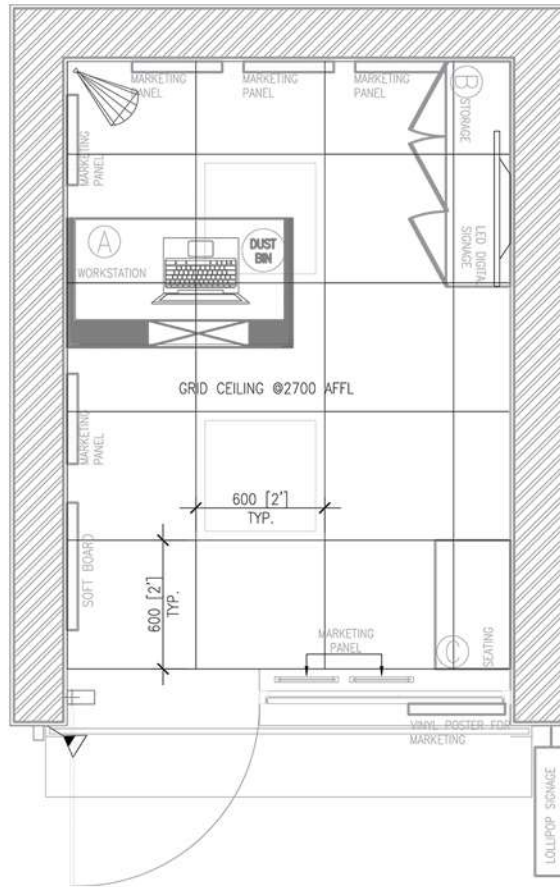

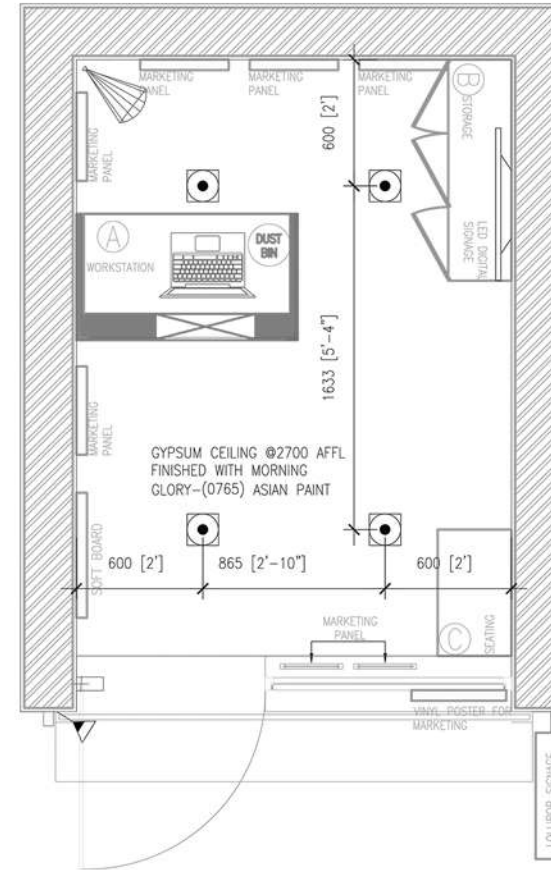

01 NTS: REFLECTED CEILING PLAN
XRC-0101 OPTION 1 WITH GRID CEILING



01 NTS: REFLECTED CEILING PLAN
XRC-0101 OPTION 2 WITH GYPSUM CEILING

CEILING FINISHES LEGEND	
REF.	FINISHES
	CH2700 AFFL GRID CEILING WITH 600 X 600MM TILES TEGULAR EDGE REGULAR COLOUR:WHITE ARMSTRONG- FINE FISSURED

LIGHT FIXTURE LEGEND	
	AELP36W, 36W, 6000K WITH LED EDISO LED & PHILIPS DRIVER
	150 W LED -BRIGHT WHITE -FOCUS LIGHT ABOVE EXTERNAL- MAIN SIGNAGE
	18 W RECESSED LED LIGHT 150X150

Drawings | Rectangular vertical format - RCP & Elec. power layout 2/2

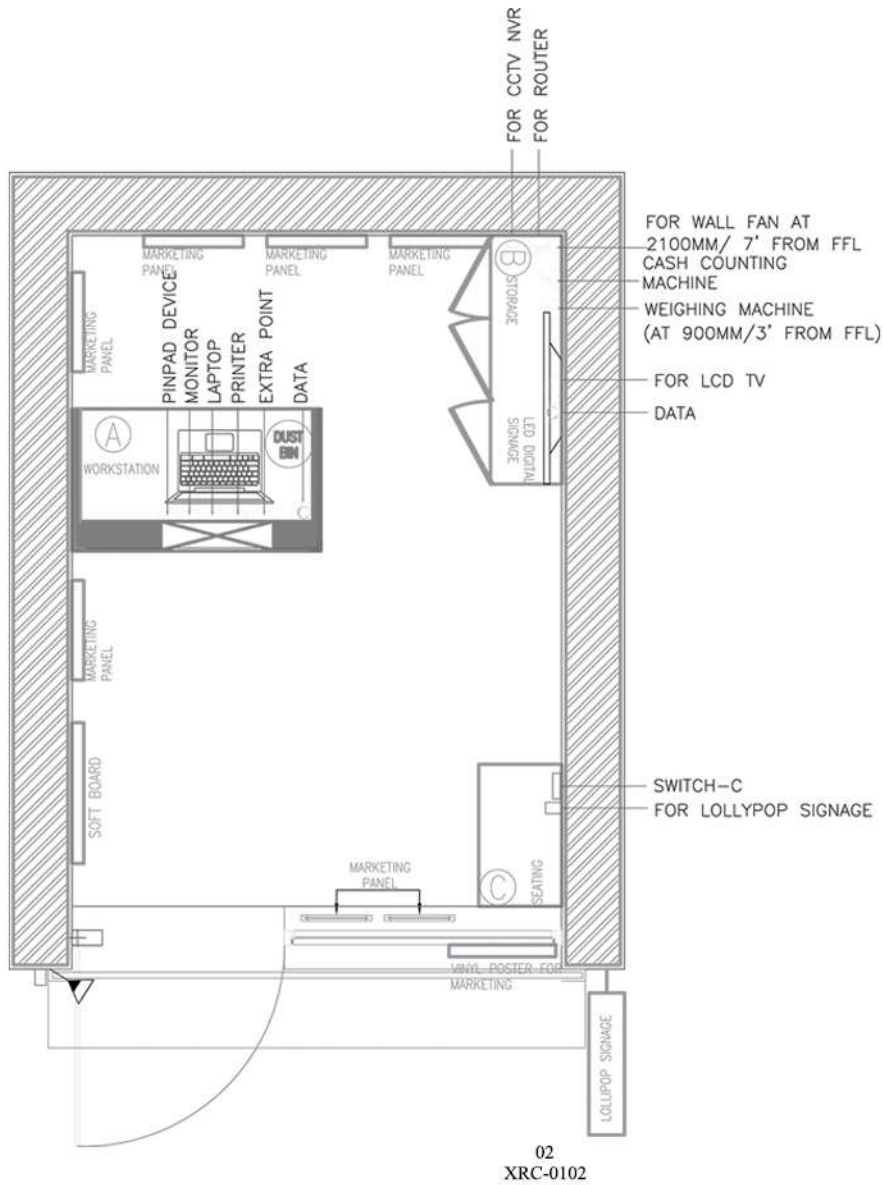

NTS: POWER LAYOUT

ELECTRICAL LEGEND:

	2/3 PIN 6A SWITCH SOCKET ON RAW POWER
	3/3 PIN 16A SWITCH SOCKET ON RAW POWER
	2/3 PIN 16A SWITCH SOCKET EXTERNAL SIGNAGE
	DATA OUTLET (CAT 6)
	WALL FAN Ø 2100mm/7' FFL IF REQUIRED
	CEILING FAN Ø 2700mm FFL/HIGH SPEED/WHITE COLOR
	32A AC SWITCH Ø 2100mm/7' FROM FFL AND AC AT 2400mm/8' FROM FFL
	AC UNIT AT 2400mm/8' FROM FFL
	SWITCH Ø 1200mm/4' FROM FFL-ANCHOR ROMA ROMA CLASSIC/ ANCHOR PENTA MODULAR WHITE PLATES
	2 kg ABC FIRE EXTINGUISHER AT 900mm FFL
	CCTV CAMERA Ø CEILING HT LVL

NOTES:

LIGHT FITTING - LED LIGHT

WORKSTATION - ALL POINTS BELOW TABLE TOP

STORAGE CABINET - ALL ELECTRICAL POINTS TO BE AT 900MM

GENSET/INVERTER TO BE PLACED AS PER SITE CONDITION.

INCASE IF THERE IS NO STORAGE WITHIN THE SITE, DB AND INVERTER TO BE KEPT NEAR THE MAIN ENTRY. VOLTAGE PARAMETERS REQUIRED FOR NORMAL OPERATING OF ATM MACHINE

AC VOLTAGE - 198V TO 257V WITH 50Hz FREQUENCY

SWITCH-A (AT 4' FROM FFL)	<ol style="list-style-type: none"> 2 WAY SWITCH FOR ONE LIGHT POINT SWITCH FOR EXTERNAL SIGNAGE LIGHT
SWITCH-B (AT 4' FROM FFL)	<ol style="list-style-type: none"> 1 SWITCH FOR ALL LIGHT POINTS 2 WAY SWITCH FOR ONE LIGHT POINT SWITCHES FOR FANS SWITCH FOR STORE ROOM LIGHT
SWITCH-C (AT 4' FROM FFL)	<ol style="list-style-type: none"> SWITCH LIGHT.
NOTE: BOTTOM OF SWITCHBOARD BELOW COUNTER -600MM/(2)	

Drawings | Rectangular Vertical format - Electrical SLD

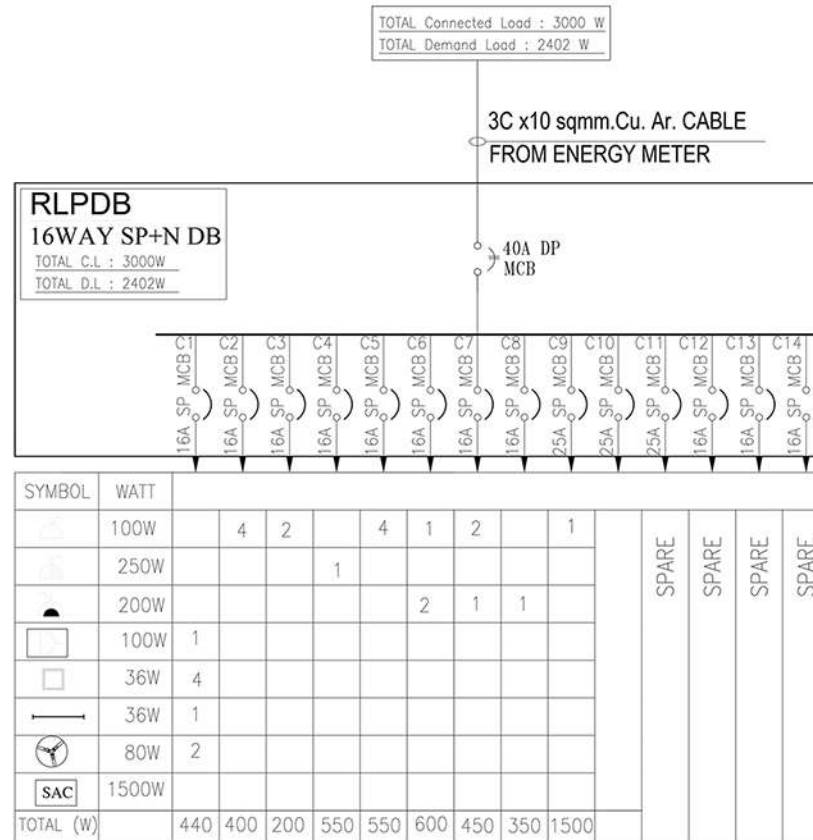

NOTES:

- APPROXIMATE REQUIRED LOAD FOR BRONZE WITHOUT ATM FORMAT -1600 W
- FINAL LOAD TO BE CALCULATED AS PER ACTUAL SITE REQUIREMENTS.
- INVERTER OR GEN-SET LOAD TO BE CALCULATED AS PER SITE REQUIREMENTS.
- FOR ALL POWER POINTS: 3CX2.5 SQMM FRLS FLEXIBLE COPPER CONDUCTOR CABLES.
- FOR SPLIT UNIT : 3CX4 SQMM FRLS FLEXIBLE COPPER CONDUCTOR CABLES.
- FOR ALL LIGHT & FAN CONNECTION: 3CX1.5 SQMM FRLS FLEXIBLE COPPER CONDUCTOR CABLES.
- FOR DATA AND TELEPHONE: 4 PAIR CAT 6 UTP WIRE.

Drawings | Rectangular vertical format - Signage layout

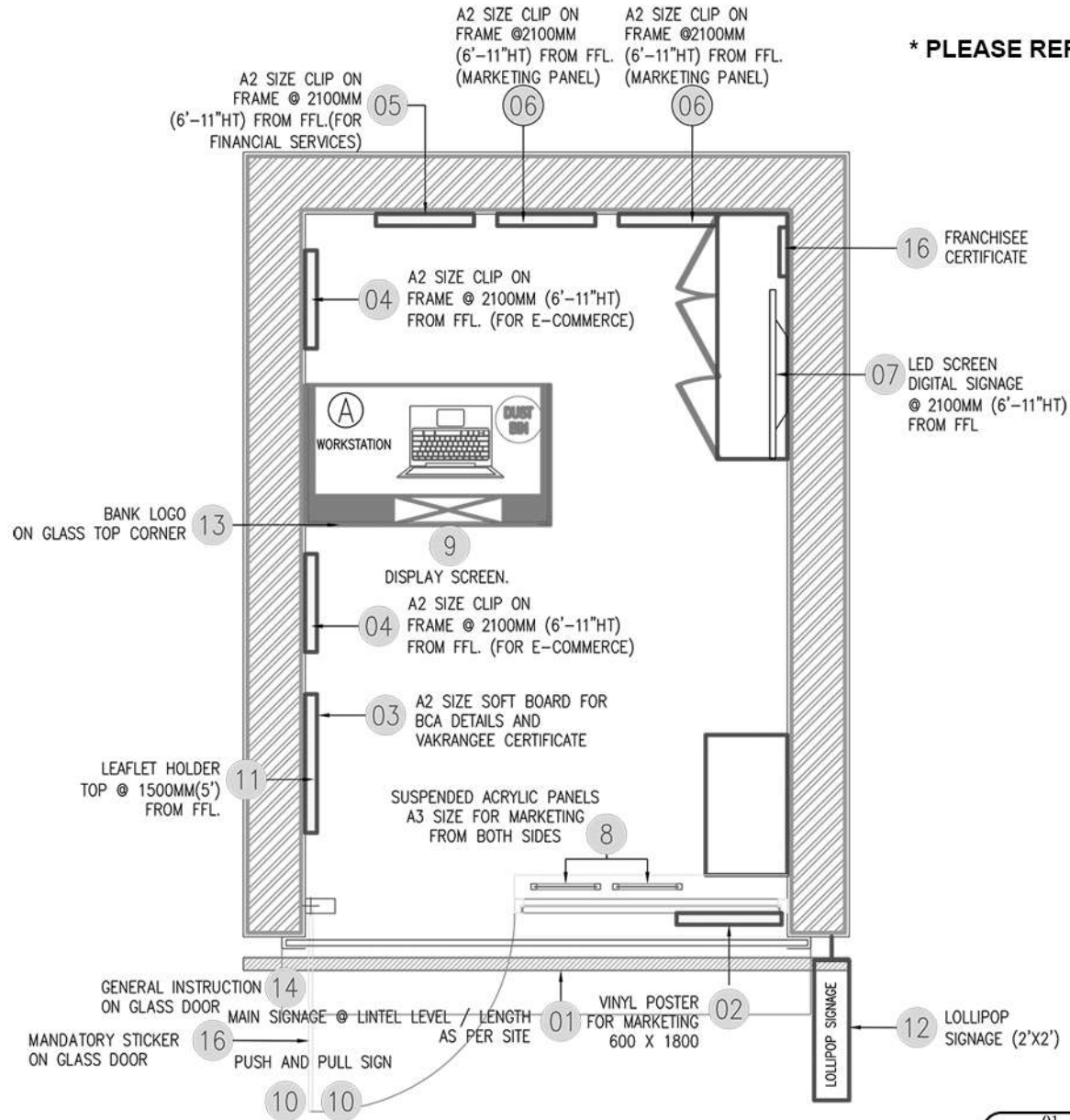

* PLEASE REFER PAGE NO-64 FOR SIGNAGE DETAILS

01 1:20 SIGNAGE LAYOUT
XSL-0101

Drawings | Rectangular vertical format - Internal elevations

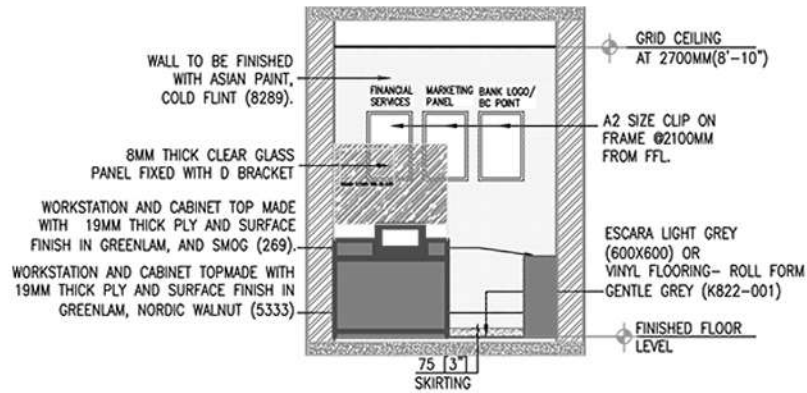

02 1:50 INTERNAL ELEVATION - 02
XIE-0101 GROUND FLOOR

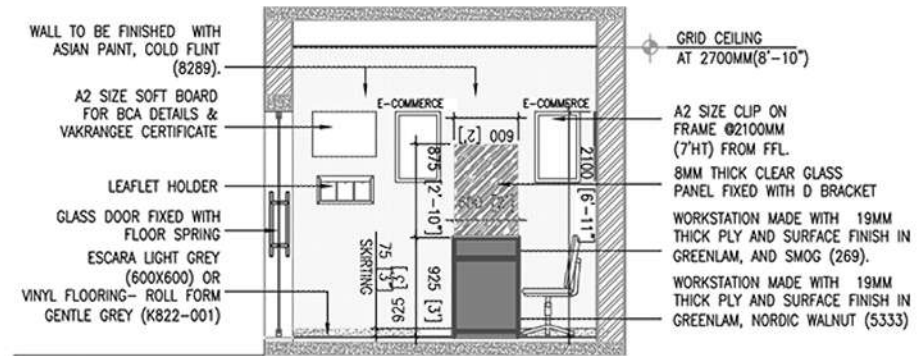

03 1:50 INTERNAL ELEVATION - 03
XIE-0101 GROUND FLOOR

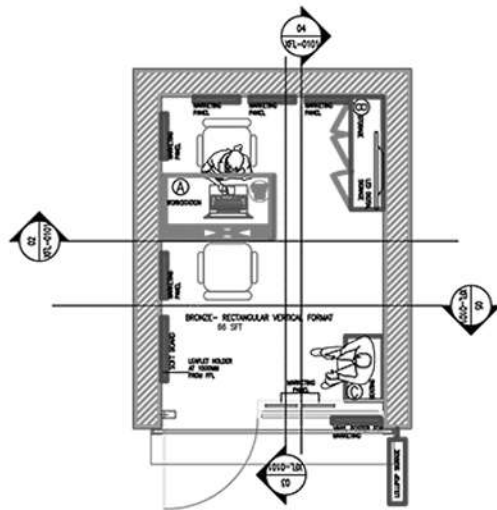

01 1:20 GENERAL ARRANGEMENT PLAN
XIE-0101 GROUND FLOOR

NOTE :
 • IF 8 MM TOUCHED GLASS IS NOT AVAILABLE, FRANCHISEE TO USE 12 MM CLEAR GLASS.
 • IF GREY OR BLACK OR WHITE POWDER COATING IS NOT AVAILABLE, FRANCHISEE TO USE NATURAL ALUMINUM FINISH.

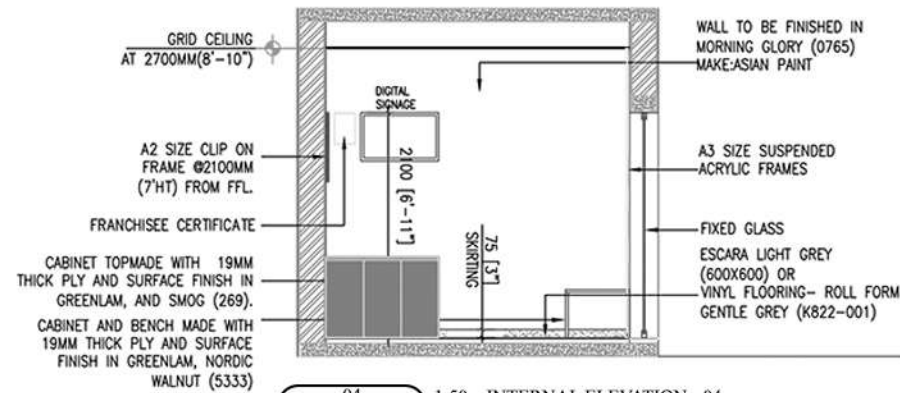

04 1:50 INTERNAL ELEVATION - 04
XIE-0101 GROUND FLOOR

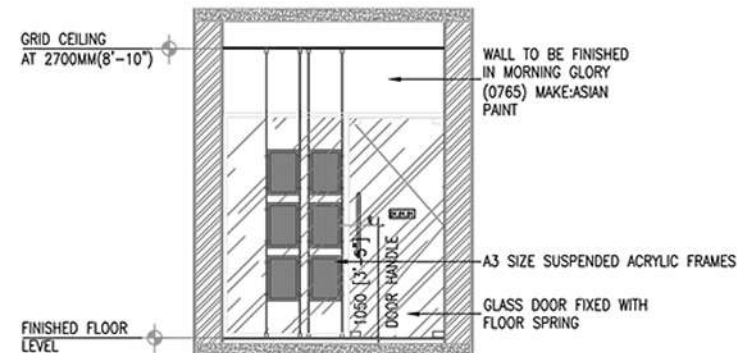

05 1:50 INTERNAL ELEVATION - 05
XIE-0101 GROUND FLOOR

Format Square

drawings

05.3

List of content • General arrangement plan • Kendra views • Civil line-out • Flooring layout • Furniture setting out • Paneling and wall finishes layout • RCP & Elec. power layout • Signage layout • Internal elevations

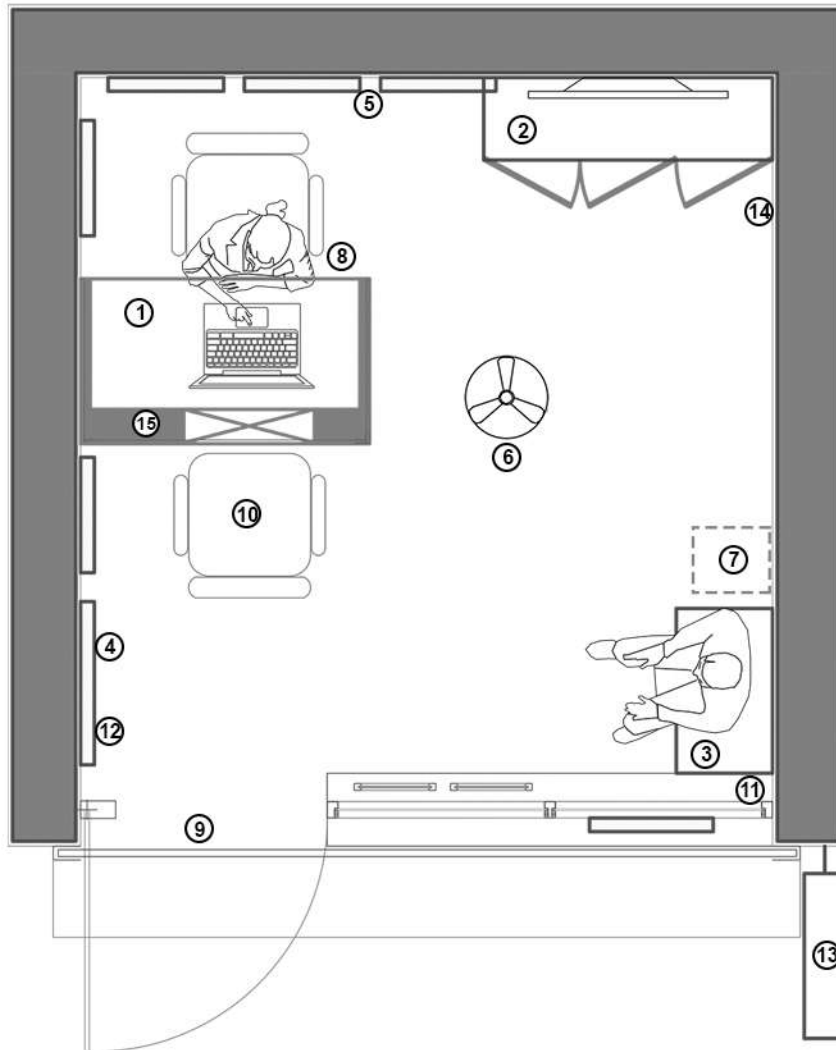

FURNITURE & EQUIPMENTS PLACEMENT (To be done by Franchisee)

Sr.No.	Items	Qty.
1	Bank & Other Services Counter	1
2	Storage Cabinet	1
3	Waiting Bench	1 (Preferable)
4	Leaflet Holder	1
5	Air Cooler / Air Conditioner	If Required
6	Fan	1
7	Water Dispenser	Preferable
8	Dustbin (Steel, Foot operated)	1
9	Doormat	1
10	Chairs	2
11	Fire Extinguisher	1
12	Soft Board	1
13	Lollipop Signage	1
14	Franchisee Certificate Frame	1
15	Sanitizing Station	As per requirment

Renders | Square format - Top View



Renders | Square format - Front View

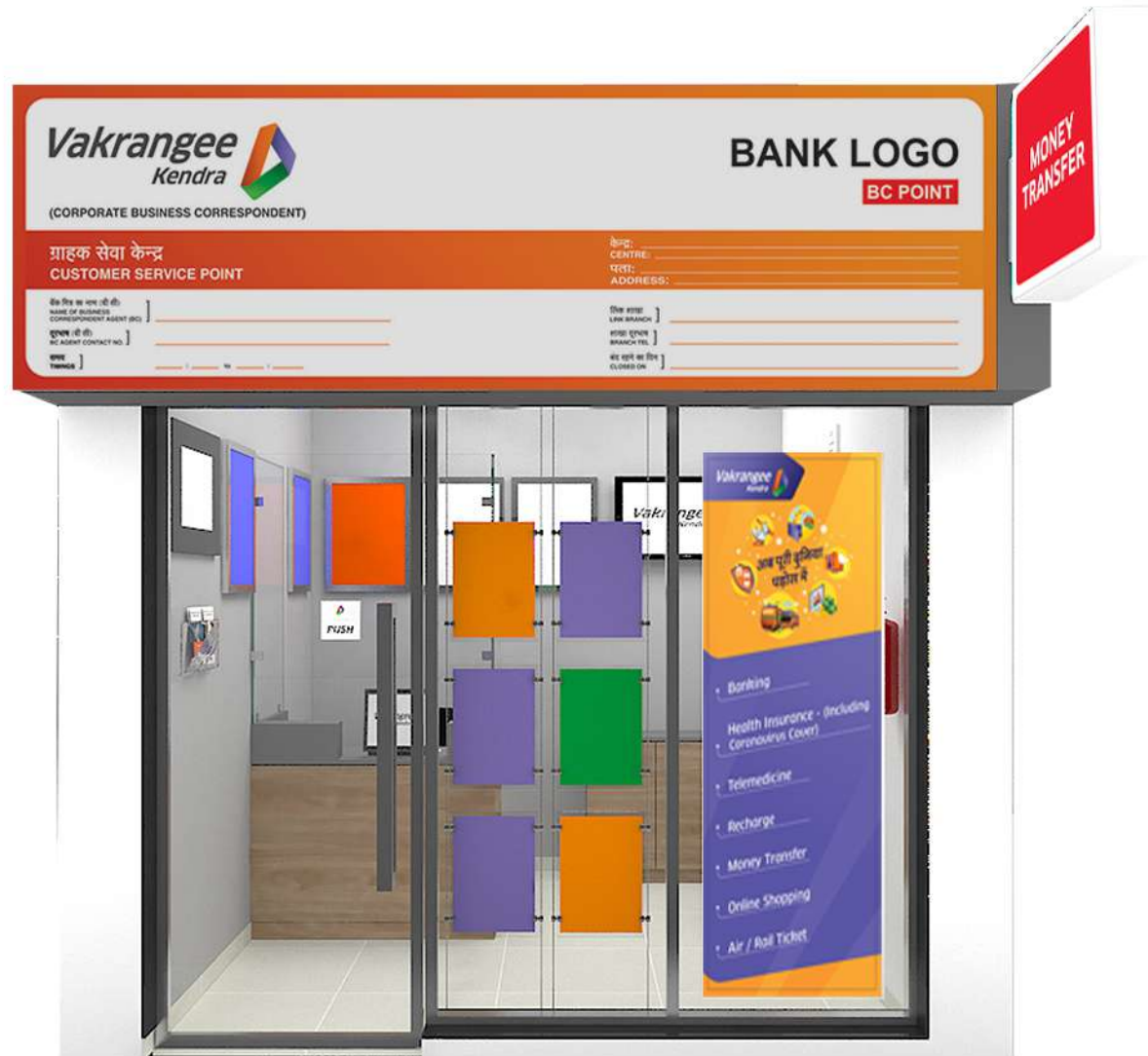

* 3D renders are for reference only. Please refer drawings for detailed specifications

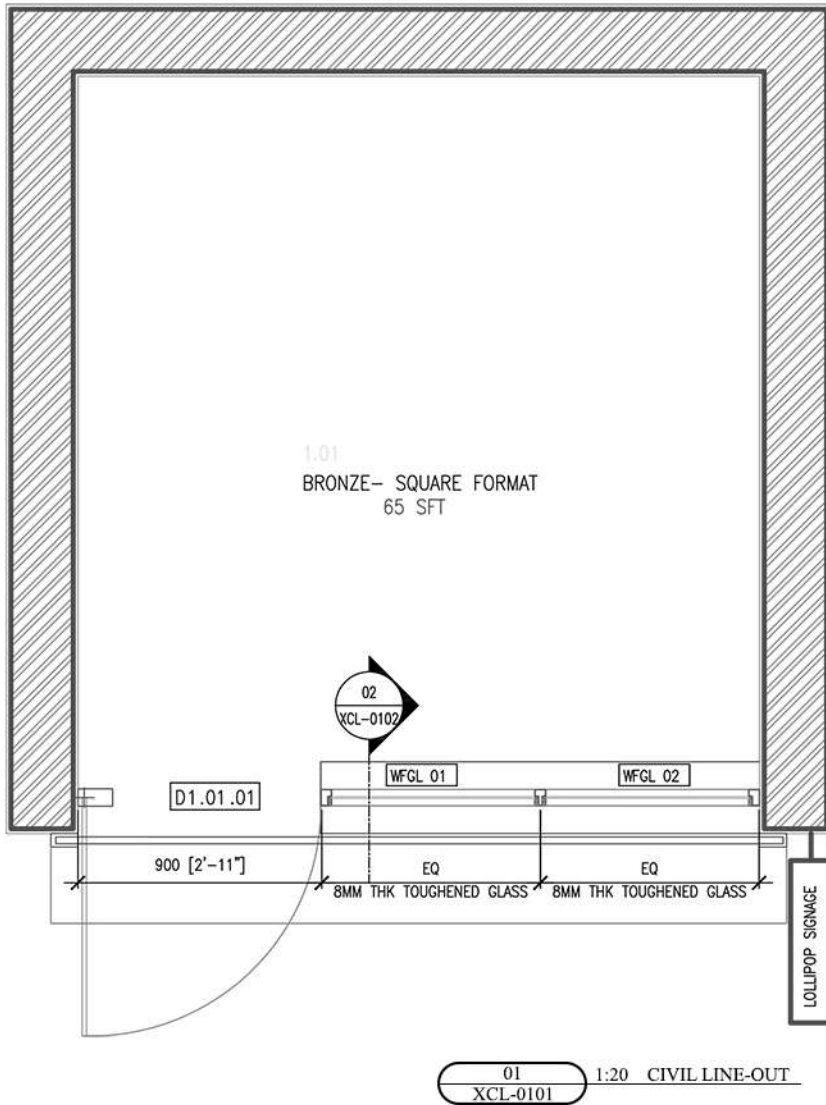

FIXED GLAZING SPECIFICATIONS

STRUCTURAL OPENING (UNFINISH TO UNFINISH)	SILL FROM FFL (IN MM)	LINTEL FROM FFL (IN MM)	WIDTH (IN MM)	HEIGHT (IN MM)	NOS.
WFGL 01	00	2150	AS PER SITE	AS PER SITE	1
WFGL 02	00	2150			1

DOOR SPECIFICATIONS

STRUCTURAL OPENING (UNFINISH TO UNFINISH)	WIDTH (IN MM)	HEIGHT (IN MM)
SERVICE AREA		
D1.01.01	900	2150

- DOOR HT. IS GIVEN CONSIDERING 50MM SCREED AND FLOOR TILE.
- ALL DOOR FINISHED HEIGHT TO BE 2100MM

Drawings | Square format - Civil lineout 2/2

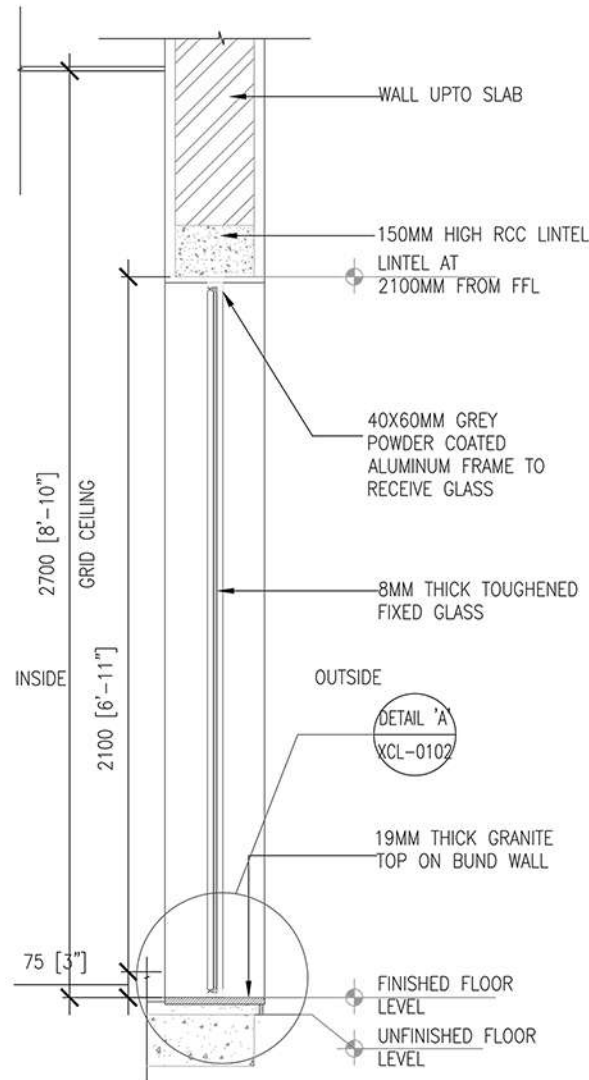

02 1:20 FIXED GLAZING SECTION-OPT-01
XCL-0102

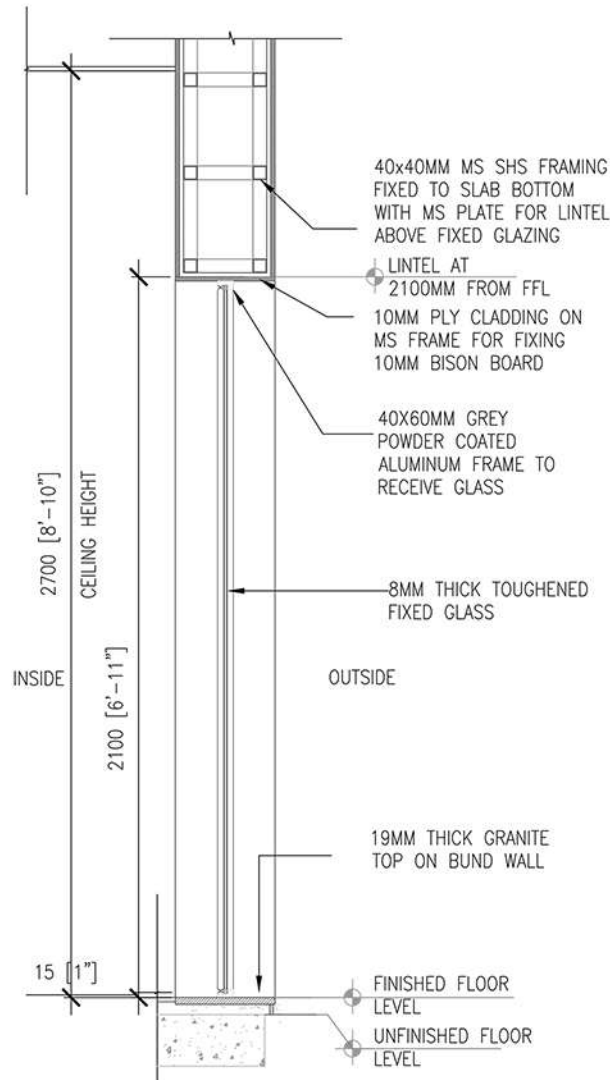

03 1:20 FIXED GLAZING SECTION-OPT-02
XCL-0102

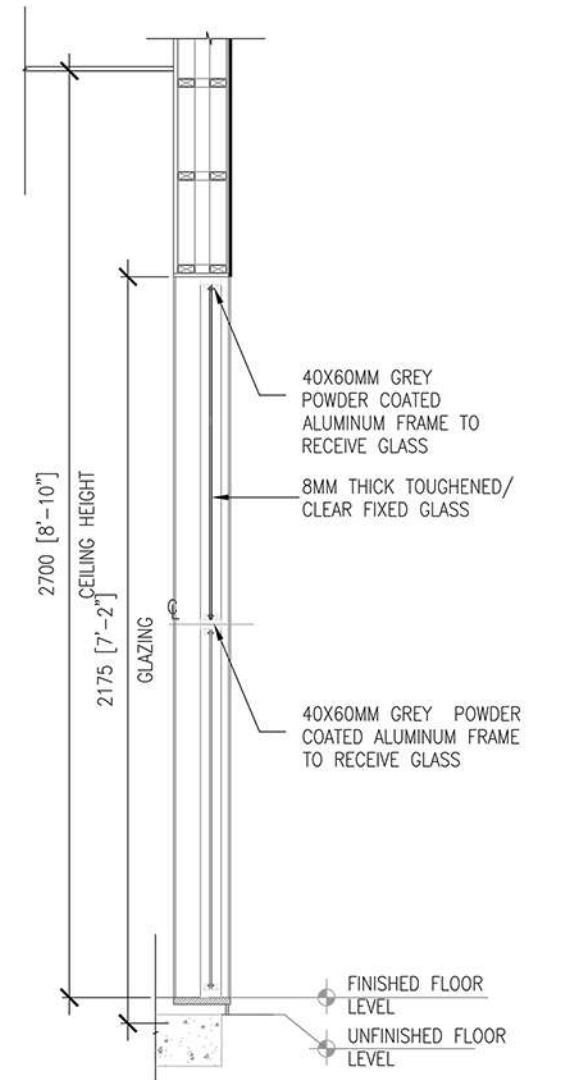



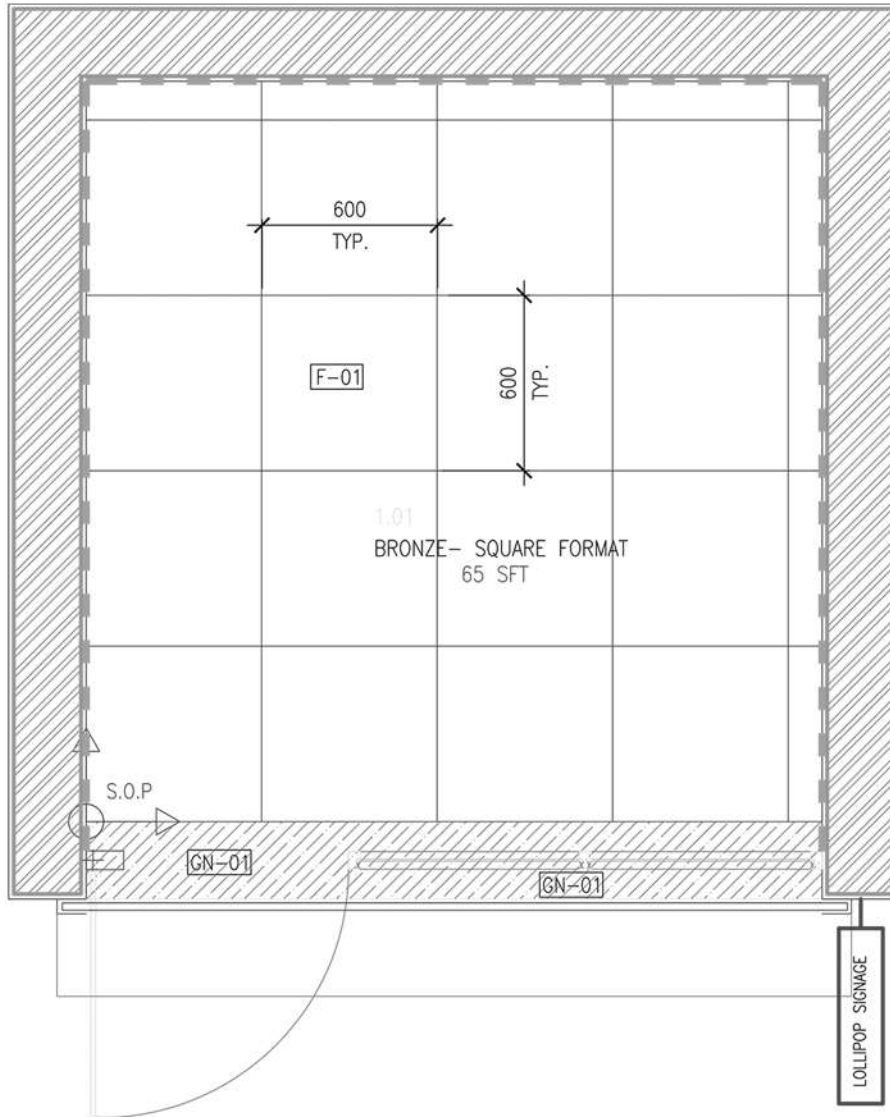

04 1:20 FIXED GLAZING SECTION-OPT-03
XCL-0102

Drawings | Square format - Flooring layout 1/2





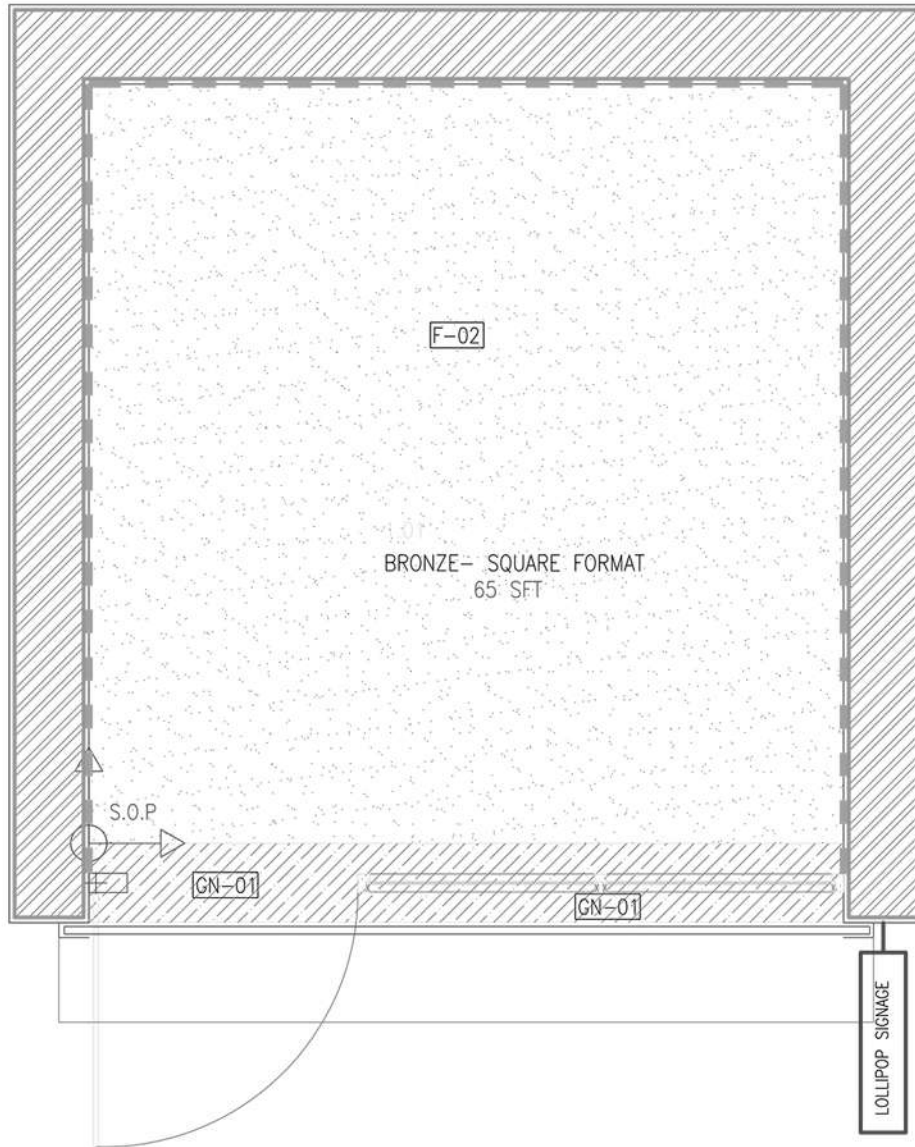

01 1:20 FLOORING LAYOUT
XFL-0101

LEGEND		
SYMBOL	SPECIFICATION	MAKE
	F01 ESCARA LIGHT GREY (600X600)	SOMANY CERAMICS
	F02 VINYL FLOORING- ROLL FORM GENTLE GREY (K822-001)	ARMSTORNG
	GN1 GRANITE	
	SK-01 75MM HIGH SKIRTING SAME AS FLOOR TILES (FOR VINYL FLOORING AND TILES FLOORING)	

Drawings | Square format - Flooring layout 2/2



LEGEND		
SYMBOL	SPECIFICATION	MAKE
	F01 ESCARA LIGHT GREY (600X600)	SOMANY CERAMICS
	F02 VINYL FLOORING- ROLL FORM GENTLE GREY (K822-001)	ARMSTORNG
	GN1 GRANITE	
	SK-01 75MM HIGH SKIRTING SAME AS FLOOR TILES (FOR VINYL FLOORING AND TILES FLOORING)	

01 1:20 FLOORING LAYOUT
XFL-0102

Drawings | Square format - Furniture setting out

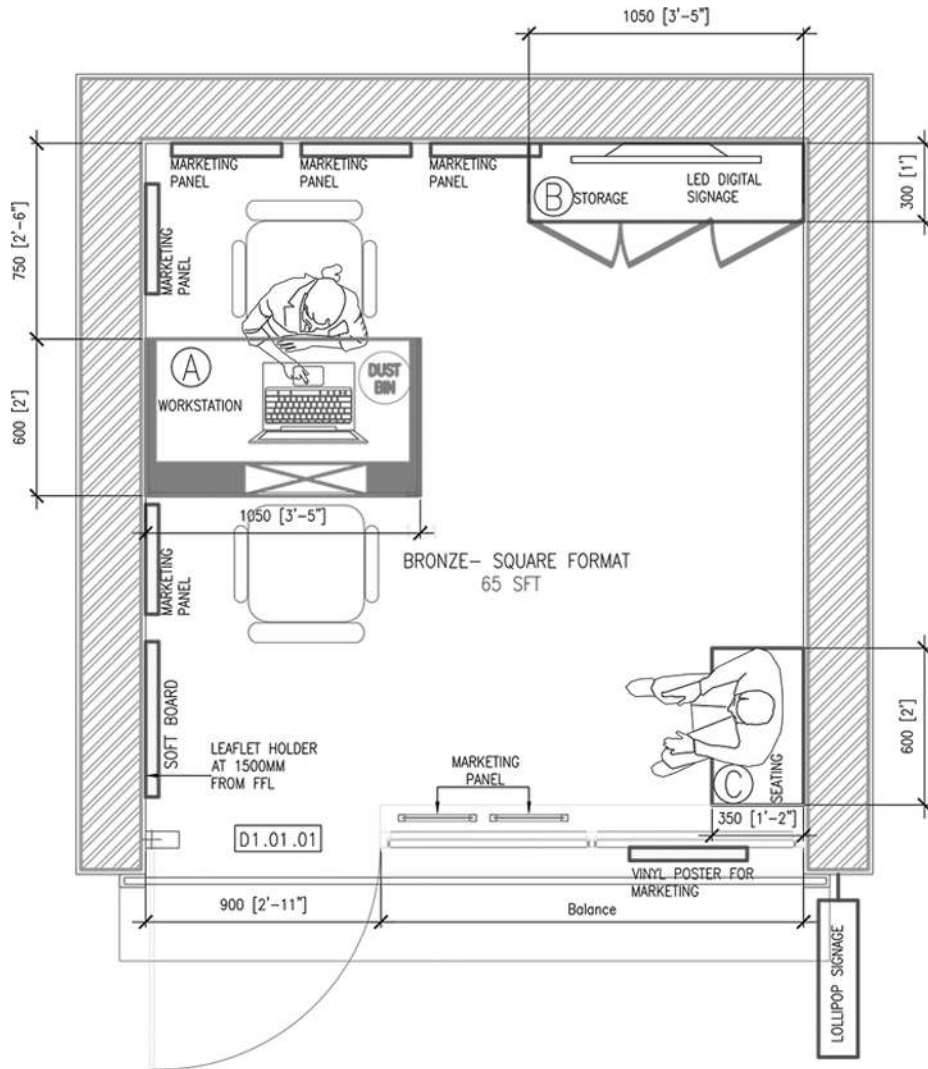

SR.NO.	CODE	DESCRIPTION	DIMENSION	FIXING	NOTES
1	(A)	MODULAR WORKSTATION	1050(L)X600(W)X 925(H)MM	LOOSE	WORKSTATION FINISH IN APPROVED LAMINATE GREENLAM, NORDIC WALNUT (5333) AND SMOG (269).
2	(B)	STORAGE CABINET	1050(L)X300(W)X 750(H)MM	LOOSE	MODULAR STORAGE CABINET FINISHED IN GREENLAM, NORDIC WALNUT (5333) & SMOG (269)
3	(C)	WAITING BENCH	600(L)X350(W)X 450(H)MM	LOOSE	MODULAR WAITING BENCH FINISHED IN GREENLAM NORDIC WALNUT (5333)

NOTE : PROVISION OF WAITING BENCH IS PREFERABLE.

01 1:20 FURNITURE SETTING OUT
XFS-0101

Drawings | Square format - Paneling and wall finishes layout

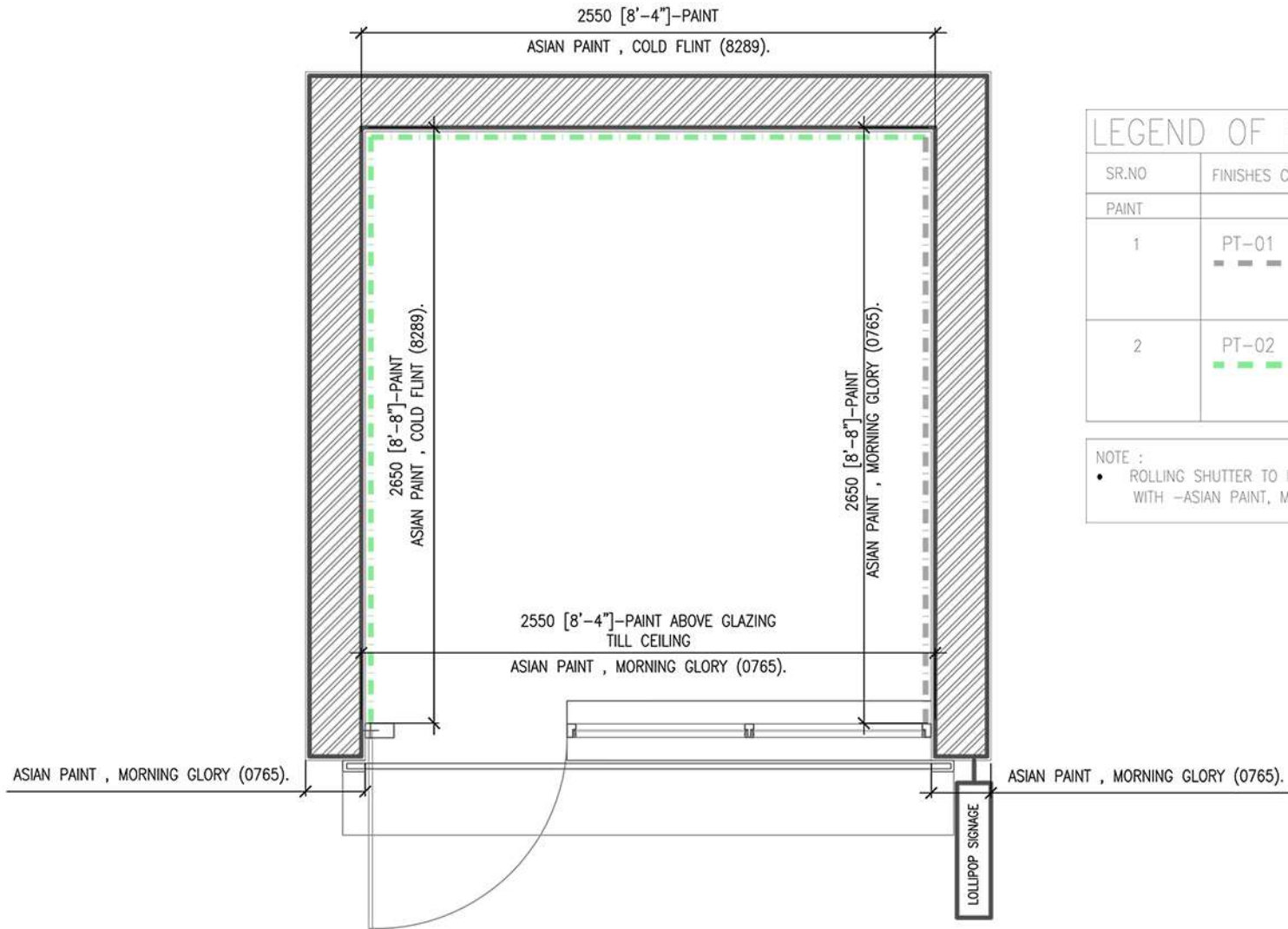

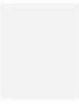
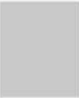
LEGEND OF FINISHES			
SR.NO	FINISHES CODE	DESCRIPTION	
PAINT			
1	PT-01 - - - -	ASIAN PLASTIC PAINT , MORNING GLORY (0765).	
2	PT-02 - - - -	ASIAN PLASTIC PAINT , COLD FLINT (8289).	

NOTE :

- ROLLING SHUTTER TO BE FINISHED WITH SYNTHETIC ENAMEL PAINT TO MATCH WITH -ASIAN PAINT, MORNING GLORY (0765)

01
XPL-0101 1:20 PANELLING LAYOUT

Drawings | Square format - RCP & Elec. power layout

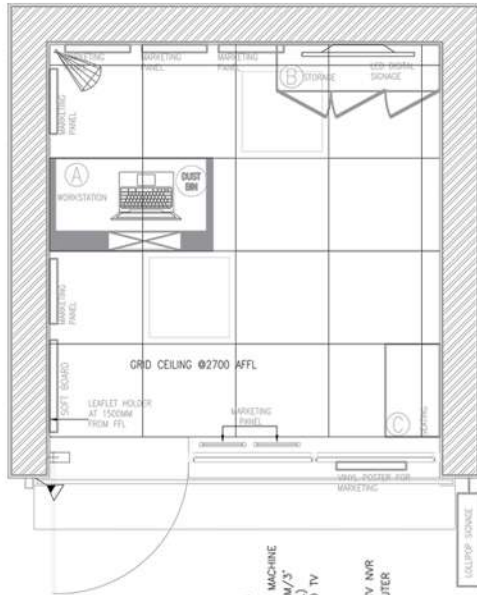

XRC-0101 NTS: REFLECTED CEILING PLAN
OPTION 1 WITH GRID CEILING

01

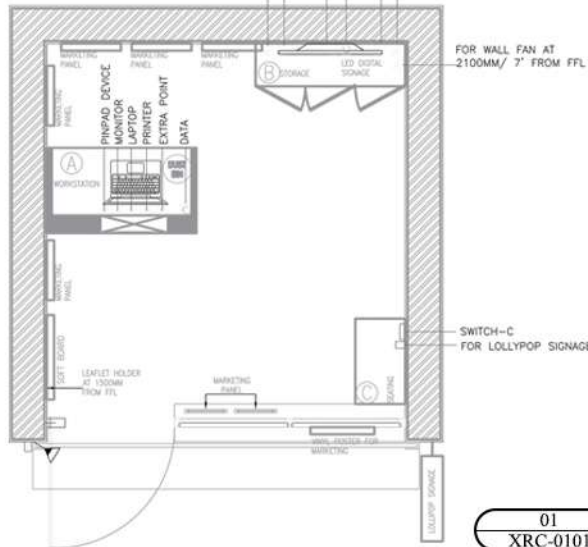

XRC-0101 NTS: REFLECTED CEILING PLAN
OPTION 2 WITH GYPSUM CEILING

NOTE : • PLEASE KEEP EXTRA CABLE LENGTH OF 2MTR AT THE CCTV CAMERA LOCATION FOR SMOOTH INSTALLATION.
• THE CASH COUNTING MACHINE SHOULD BE VISIBLE IN CAMERA

CEILING FINISHES LEGEND	
REF.	FINISHES
	02700 AFFL GRID CEILING WITH 600 X 600MM TILES REGULAR EDGE REGULAR COLOUR/WHITE ANTI-GLOSS- FINE REQUIRED

LIGHT FIXTURE LEGEND	
	HELP30W, 30W, 6000K WITH LED ED60 LED & PHILIPS DRIVER
	150 W LED -BRIGHT WHITE -FOCUS LIGHT ABOVE EXTERNAL- MAIN SIGNAGE
	18 W RECESSED LED LIGHT 150X150
	36/ 42XCEILING FAN @ 2700mm FFL HIGH SPEED/WHITE COLOR HANELLS/DANA/DORIS/SONIPON & GREDES

ELECTRICAL LEGEND:

	2/3 PIN 6A SWITCH SOCKET ON RAW POWER
	3/3 PIN 16A SWITCH SOCKET ON RAW POWER
	2/3 PIN 16A SWITCH SOCKET EXTERNAL SIGNAGE
	DATA OUTLET (CAT 6)
	WALL FAN @ 2100mm/7' FFL IF REQUIRED
	CEILING FAN @ 2700mm FFL/HIGH SPEED/WHITE COLOR
	32A AC SWITCH @ 2100mm/7' FROM FFL AND AC AT 2400mm/8' FROM FFL
	AC UNIT AT 2400mm/8' FROM FFL
	SWITCH @ 1200mm/4' FROM FFL-ANCHOR ROMA ROMA CLASSIC/ ANCHOR PENTA MODULAR WHITE PLATES
	2 kg ABC FIRE EXTINGUISHER AT 900mm FFL
	CCTV CAMERA @ CEILING HT LVL

NOTES:
LIGHT FITTING - LED LIGHT
WORKSTATION - ALL POINTS BELOW TABLE TOP
STORAGE CABINET - ALL ELECTRICAL POINTS TO BE AT ROOMM
GENSET/INVERTER TO BE PLACED AS PER SITE CONDITION.
INCASE IF THERE IS NO STORAGE WITHIN THE SITE, DB AND INVERTER TO BE KEPT NEAR THE MAIN ENTRY.
VOLTAGE PARAMETERS REQUIRED FOR NORMAL OPERATING OF ATM MACHINE
AC VOLTAGE - 198V TO 257V WITH 50HZ FREQUENCY

SWITCH-A (AT 4' FROM FFL)	1. 2 WAY SWITCH FOR ONE LIGHT POINT 2. SWITCH FOR EXTERNAL SIGNAGE LIGHT
SWITCH-B (AT 4' FROM FFL)	1. 1 SWITCH FOR ALL LIGHT POINTS 2. 2 WAY SWITCH FOR ONE LIGHT POINT 3. SWITCHES FOR FANS 4. SWITCH FOR STORE ROOM LIGHT
SWITCH-C (AT 4' FROM FFL)	1. SWITCH LIGHT.

NOTE: BOTTOM OF SWITCHBOARD BELOW COUNTER -600MM/(2)

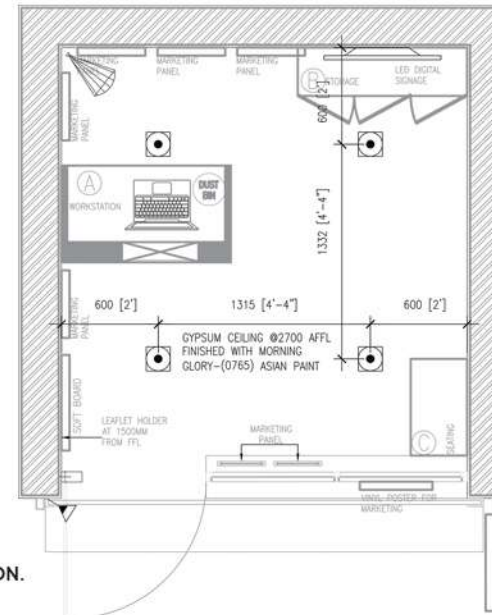

XRC-0101 NTS: POWER LAYOUT

Drawings | Square format - Electrical SLD

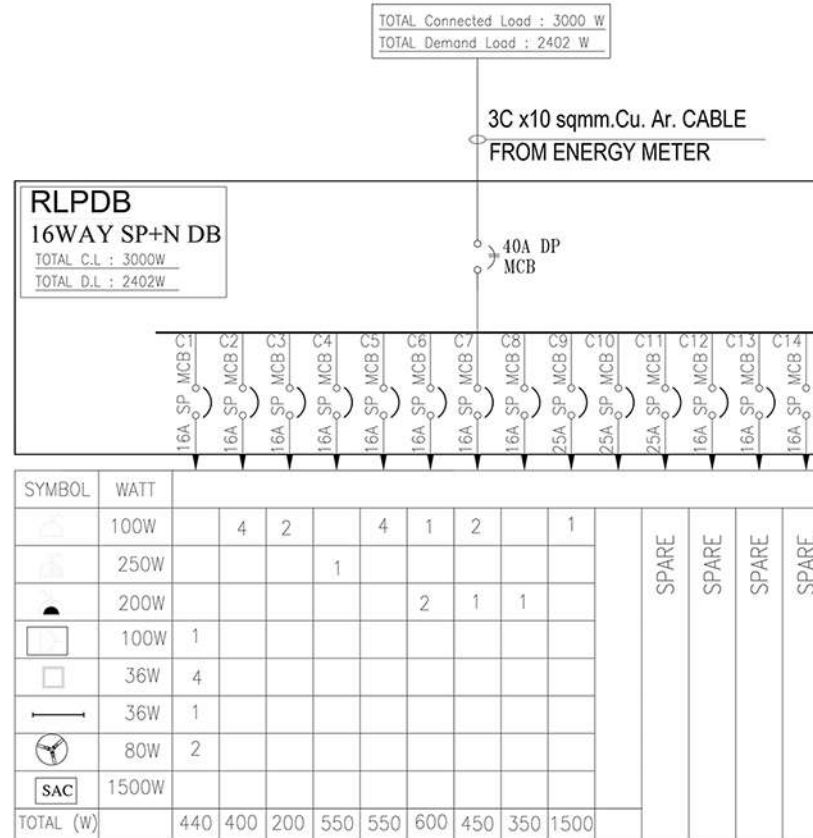

NOTES:

- APPROXIMATE REQUIRED LOAD FOR BRONZE WITHOUT ATM FORMAT -1600 W
- FINAL LOAD TO BE CALCULATED AS PER ACTUAL SITE REQUIREMENTS.
- INVERTER OR GEN-SET LOAD TO BE CALCULATED AS PER SITE REQUIREMENTS.
- FOR ALL POWER POINTS: 3CX2.5 SQMM FRLS FLEXIBLE COPPER CONDUCTOR CABLES.
- FOR SPLIT UNIT : 3CX4 SQMM FRLS FLEXIBLE COPPER CONDUCTOR CABLES.
- FOR ALL LIGHT & FAN CONNECTION: 3CX1.5 SQMM FRLS FLEXIBLE COPPER CONDUCTOR CABLES.
- FOR DATA AND TELEPHONE: 4 PAIR CAT 6 UTP WIRE.

* PLEASE REFER PAGE NO-64 FOR SIGNAGE DETAILS

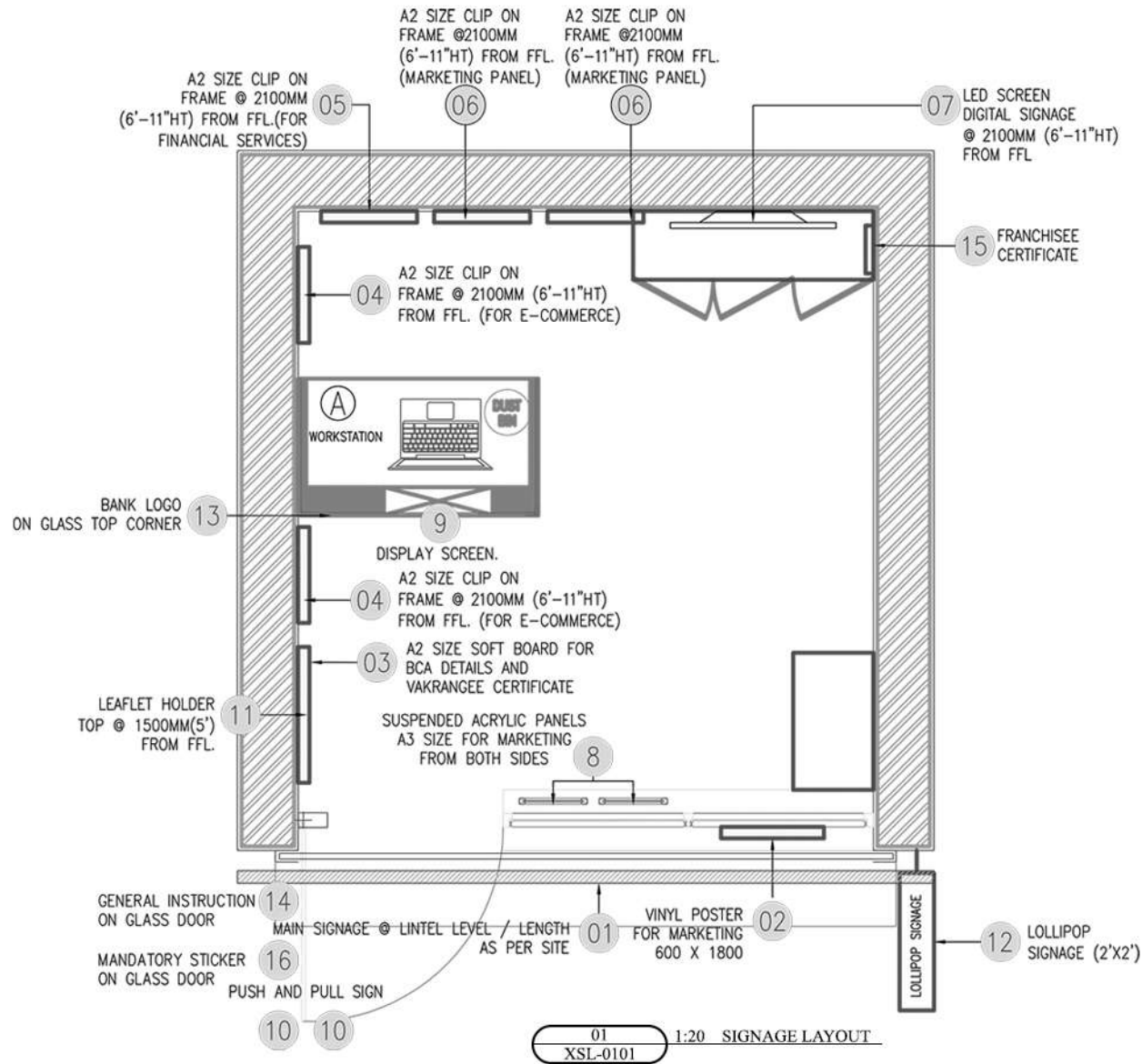

Drawings | Square format - Internal elevations

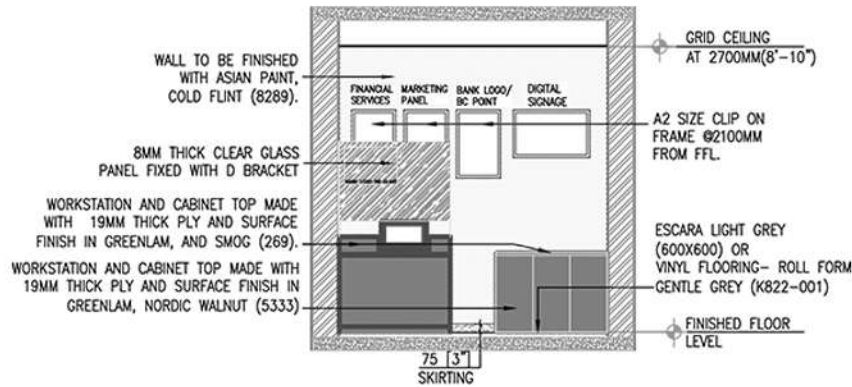

04 1:50 INTERNAL ELEVATION-04
XIE-0101

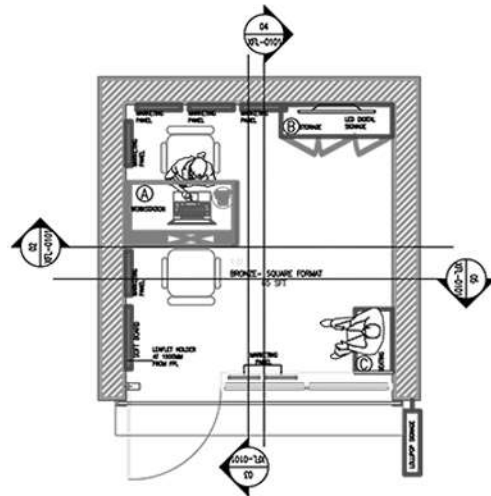

01 1:20 GENERAL ARRANGEMENT PLAN
XIE-0101

NOTE :

- IF 8 MM TOUGHENED GLASS IS NOT AVAILABLE, FRANCHISEE TO USE 12 MM CLEAR GLASS.
- IF GREY OR BLACK OR WHITE POWDER COATING IS NOT AVAILABLE, FRANCHISEE TO USE NATURAL ALUMINUM FINISH.

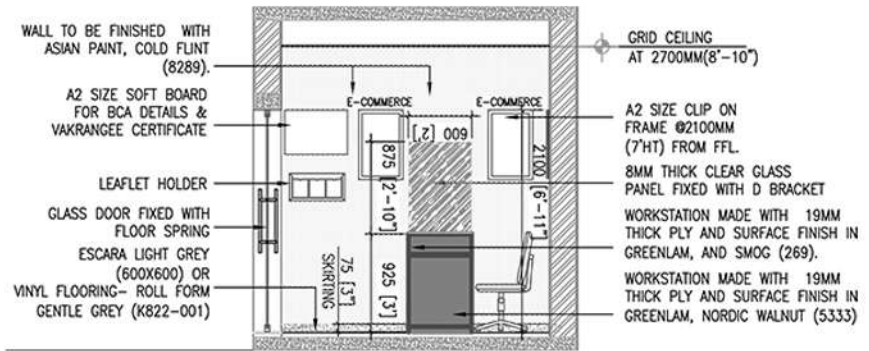

03 1:50 INTERNAL ELEVATION-03
XIE-0101

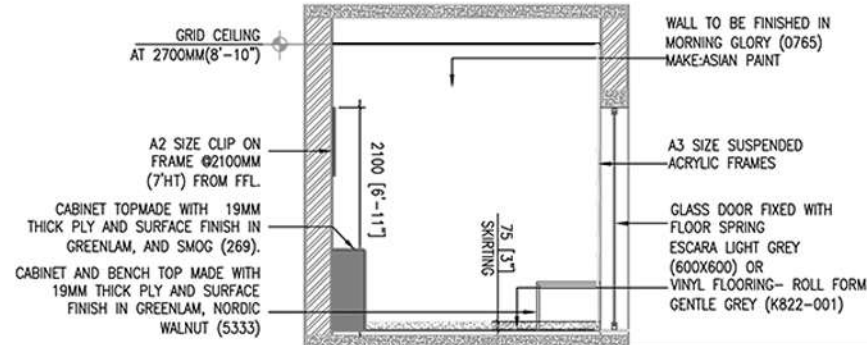

02 1:50 INTERNAL ELEVATION-02
XIE-0101

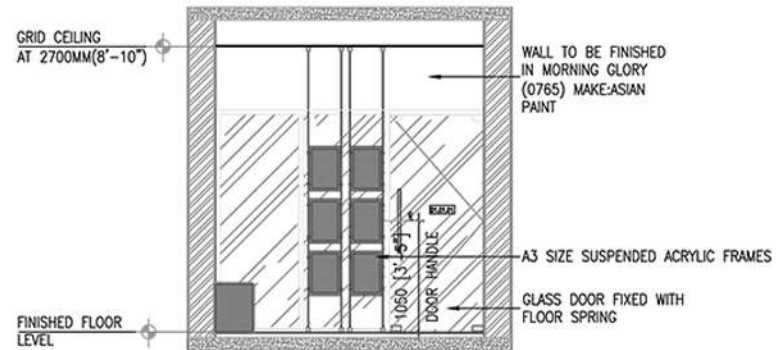

05 1:50 INTERNAL ELEVATION-05
XIE-0101

Typical DETAILS

drawings

05.4

Drawings | Typical details - External elevations

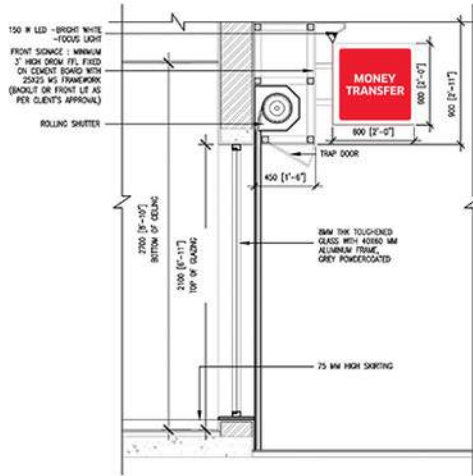
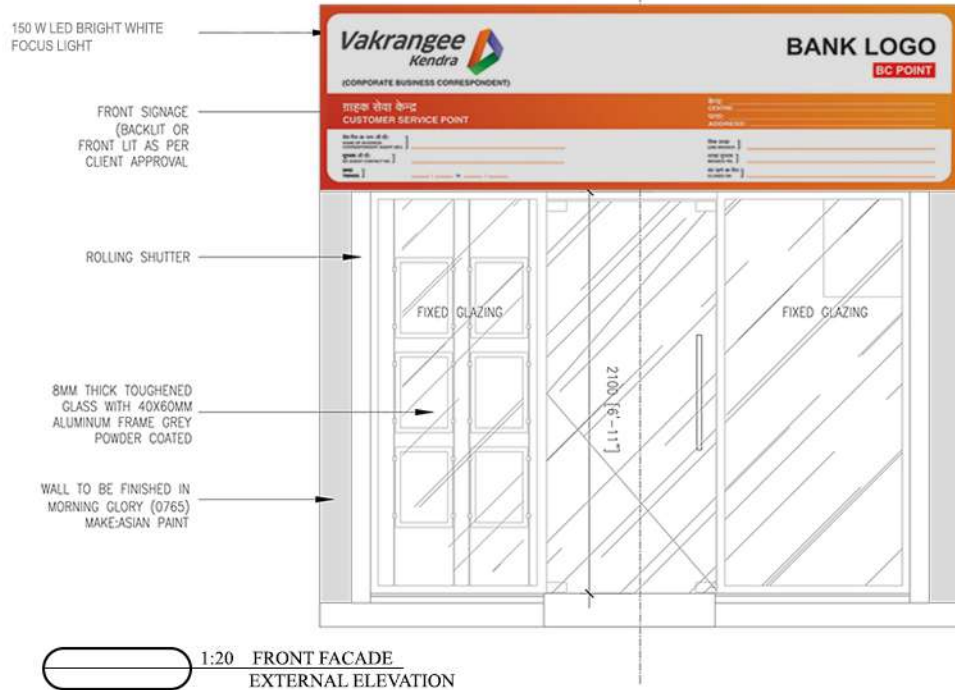

03 1:20 SECTION EXTERNAL ELEVATION

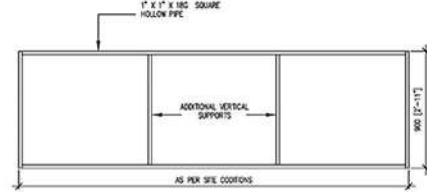

04 NTS ELEVATION FRONT SIGNAGE FRAME WORK

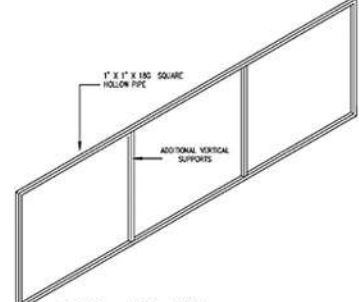

04 NTS VIEW FRONT SIGNAGE FRAME WORK

LOLLIPOP SIGNAGE -

OPTION 1
DOUBLE SIDED WALL MOUNTED FLANGE
SIZE - 2ft x 2ft x 5 inch(depth)

MATERIAL SPECS:
WHITE COLOUR ACRYLIC MOLDED FLANGE WITH ALUMINUM FRAME.
TO BE FIXED WITH M. S BRACKETS ON WALL WITH FASTENERS.
VINYL - STAR/3M/LG VINYL
PRINTING - 3RD GENERATION HP LATEX PRINTING OR PLOTTER CUT VINYL
LIGHT - LED STRIP LIGHTING SYSTEM

OPTION 2
GLOW SIGNBOARD WITH 1"x1" MS SQUARE PIPE BOX FRAME WITH ALUMINUM L ANGLE ON BORDER FOR EDGE TO EDGE LIGHTING WITH LED STRIP / TUBELIGHT.
PRINTING - BACKLIT STARFLEX ON HP LATEX PRINTER WITH BACK TO BACK FLEX PRINTING WITH 3 YEAR WARRANTY

Note :

- Lollipop : Mandatory. Franchisee's can opt for additional locations apart from as shown in this page.
- Main Signboard : Flex artwork will be provided by Vakrangee

Main Signage Specifications

- Flex Media - StarFlex - Avery dennison - LG Flex quality - Front lit flex with Grey or Black back - minimum 14 oz.
- Printing technology - HP latex - Third Generation Lamination - Gloss

Drawings | Typical details - Door 1/2

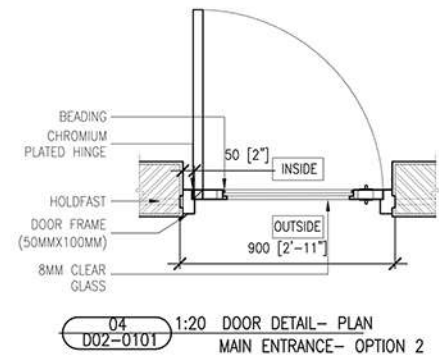
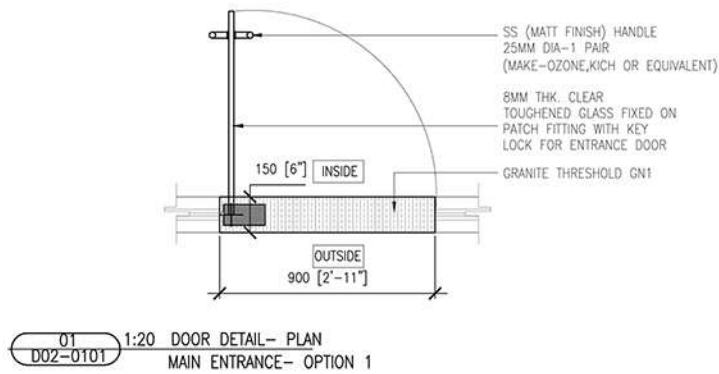
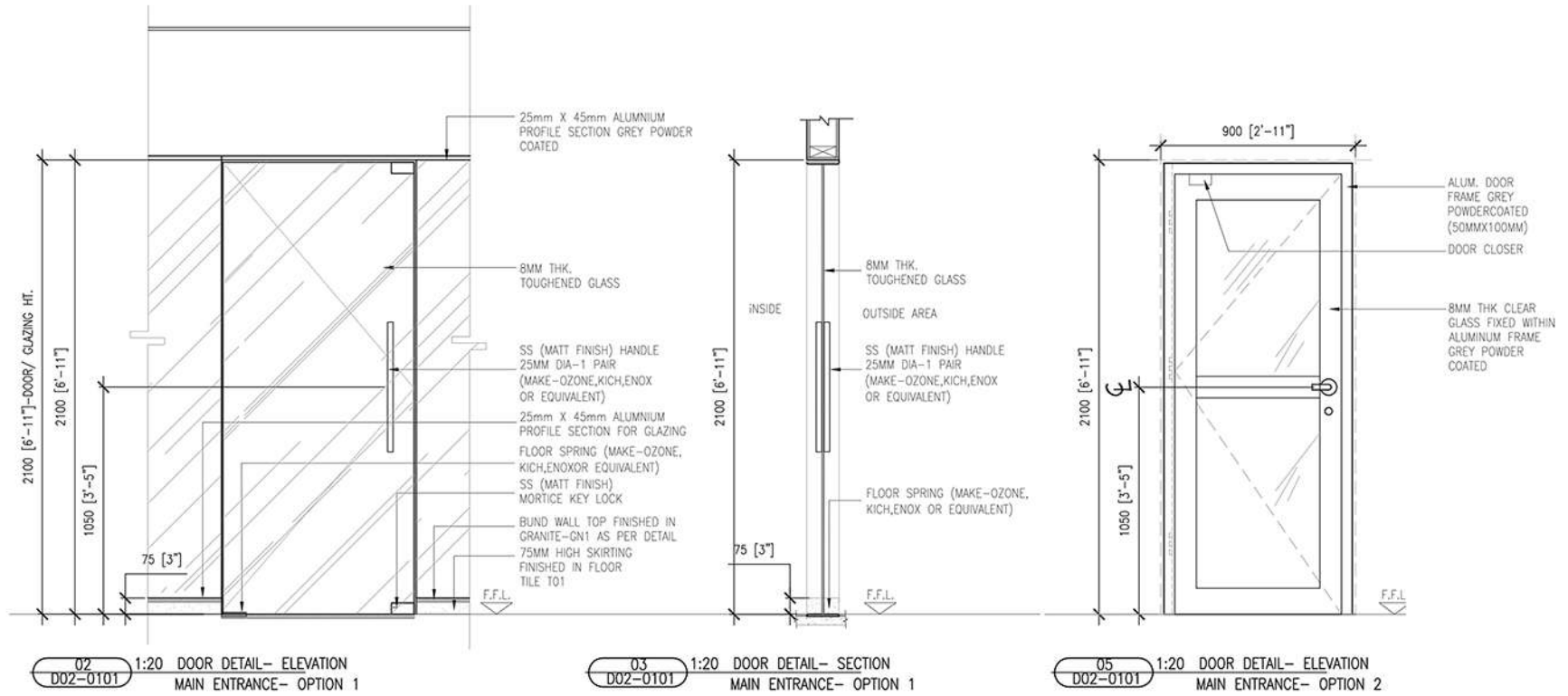

Drawings | Typical details - Door 2/2

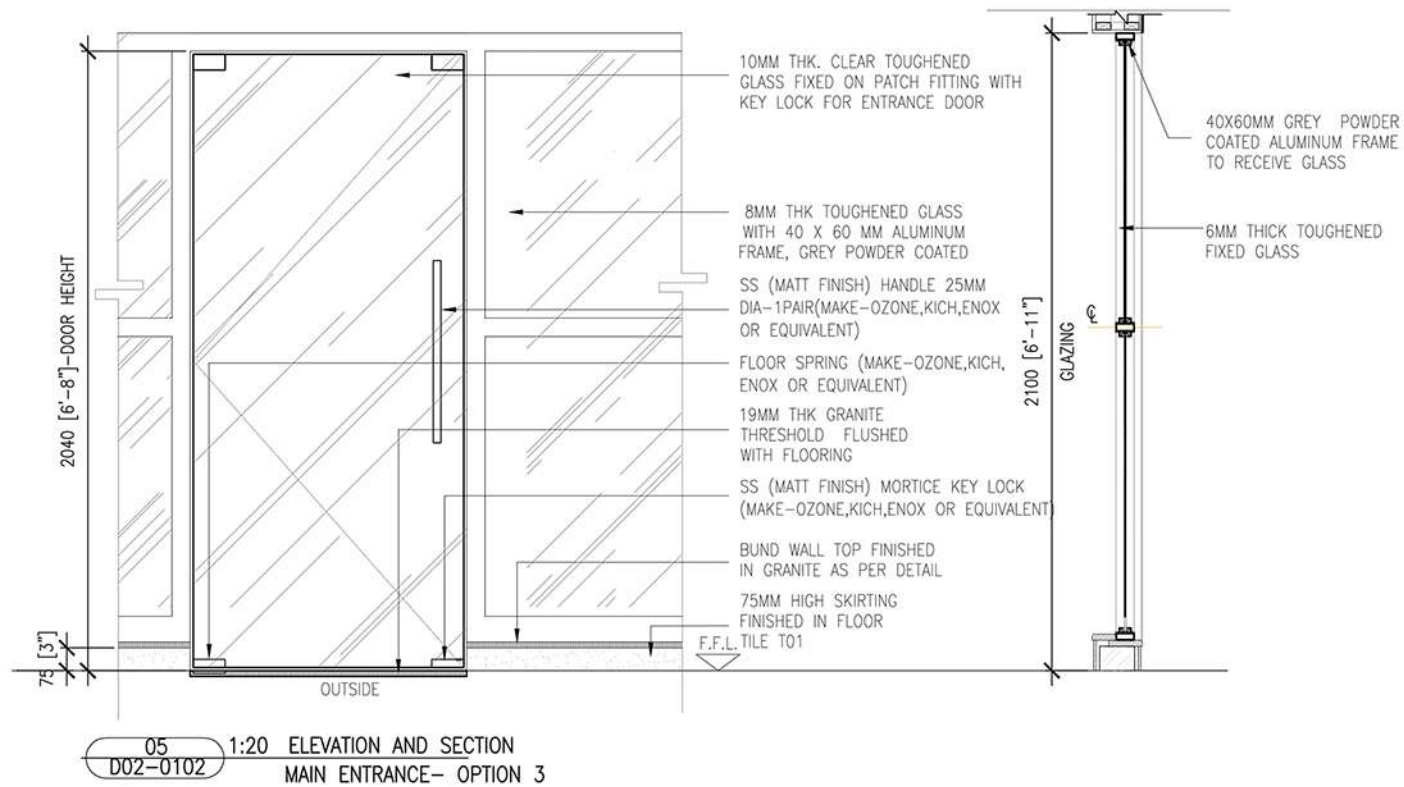

NOTE:

- TOUGHENED GLASS IS RECOMMENDED FOR SAFETY. IF 8 MM TOUGHENED GLASS IS NOT AVAILABLE, FRANCHISEE TO USE 12 MM CLEAR GLASS.
- IF GREY POWDER COATING IS NOT AVAILABLE, FRANCHISEE TO USE NATURAL ALUMINUM FINISH.

Drawings | Typical details - Furniture 1/3

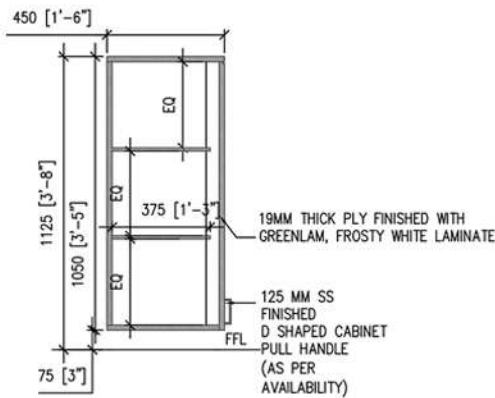
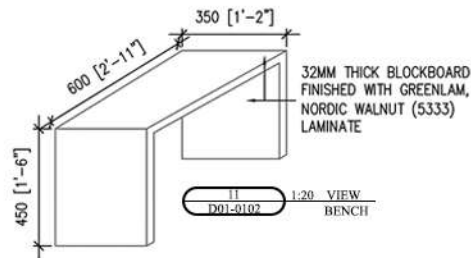
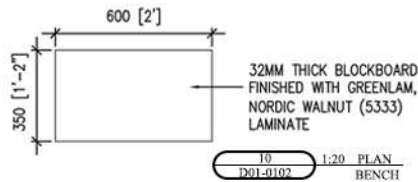
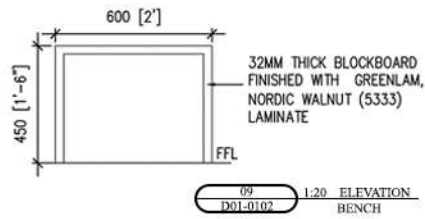

05 D01-0102 1:20 SECTION OVERHEAD STORAGE

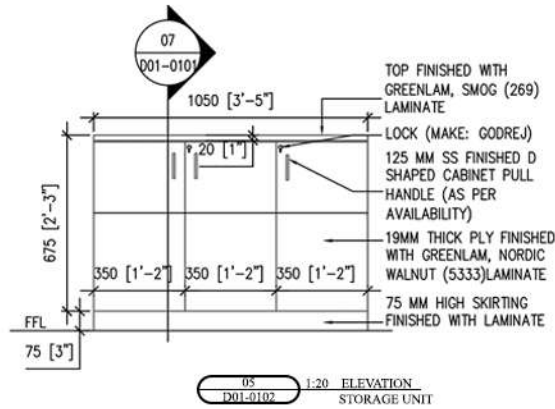

05 D01-0102 1:20 ELEVATION STORAGE UNIT

NOTE: LENGTH OF THE STORAGE UNIT WILL BE SAME AS THE LENGTH OF WORKSTATION.

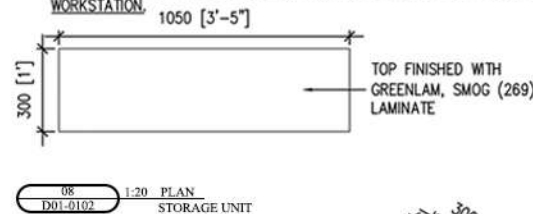

08 D01-0102 1:20 PLAN STORAGE UNIT

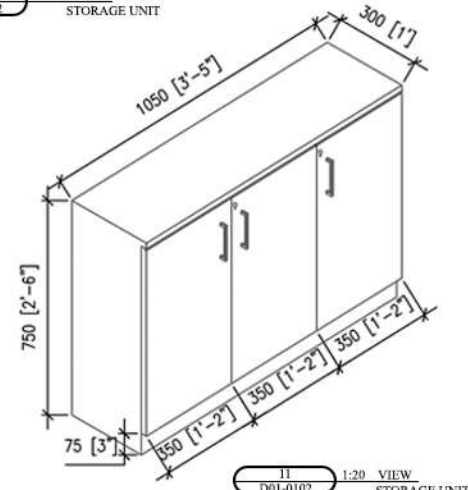

11 D01-0102 1:20 VIEW STORAGE UNIT

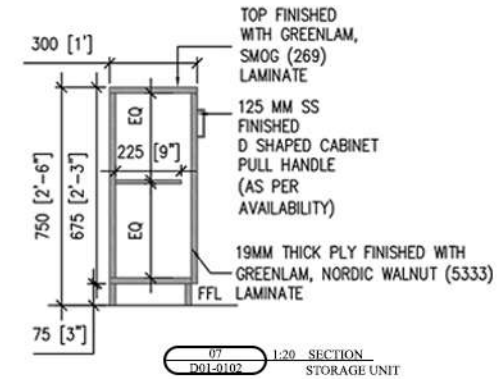

07 D01-0102 1:20 SECTION STORAGE UNIT

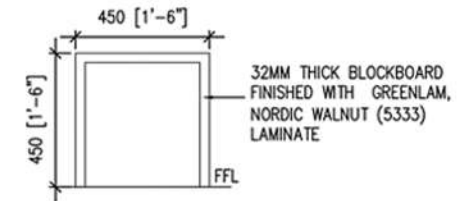

09 D01-0102 1:20 ELEVATION STORAGE UNIT

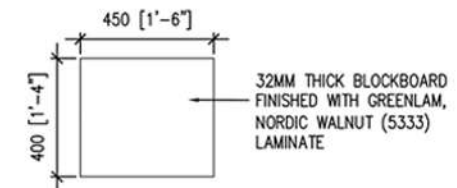

10 D01-0102 1:20 ELEVATION STORAGE UNIT

Drawings | Typical details - Furniture 2/3

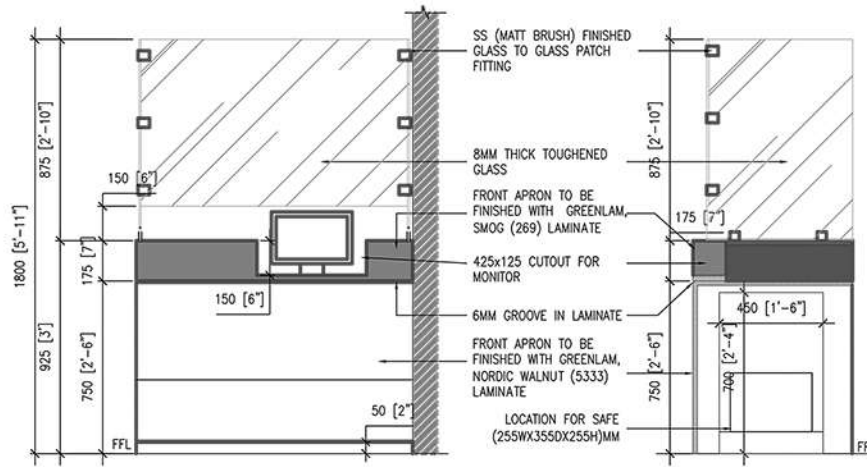

02 1:20 FRONT ELEVATION
D01-0102 WORKSTATION

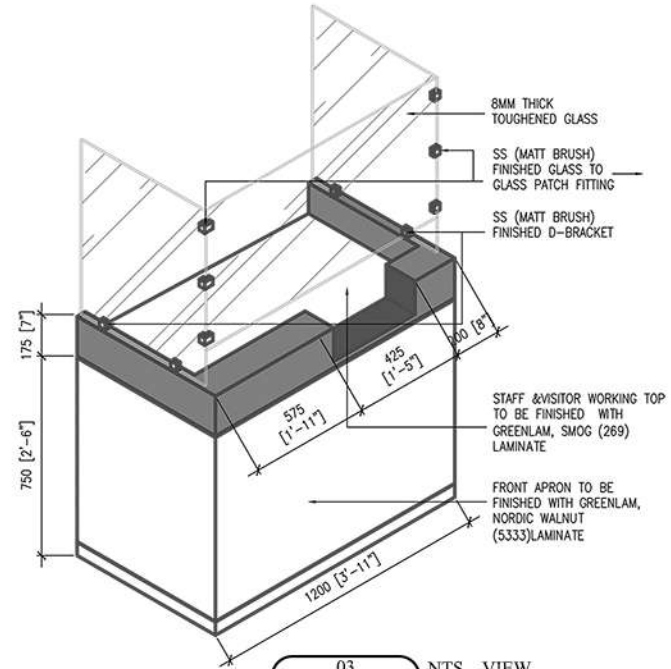

03 NTS VIEW
D01-0102 WORKSTATION

05 1:20 SECTION
D01-0102 WORKSTATION

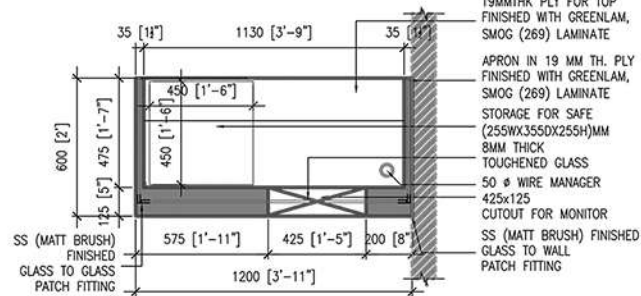

01 1:20 PLAN
D01-0102 WORKSTATION

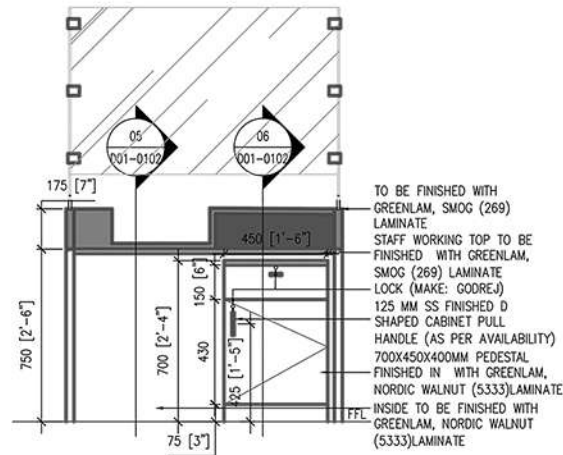

04 1:20 INTERNAL ELEVATION
D01-0102 WORKSTATION

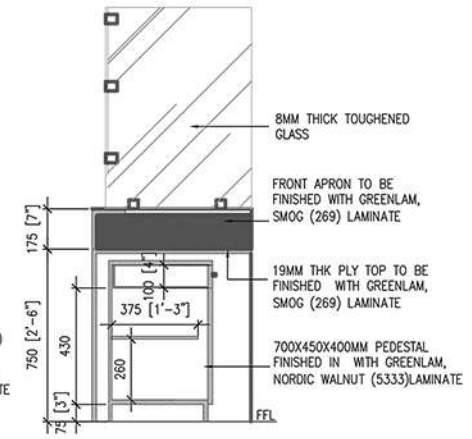

06 1:20 SECTION
D01-0102 WORKSTATION

Drawings | Typical details - Furniture 3/3

02
D01-0104 1:10 ELEVATION (FROM INSIDE)
FRAMES SUSPENSION SYSTEM

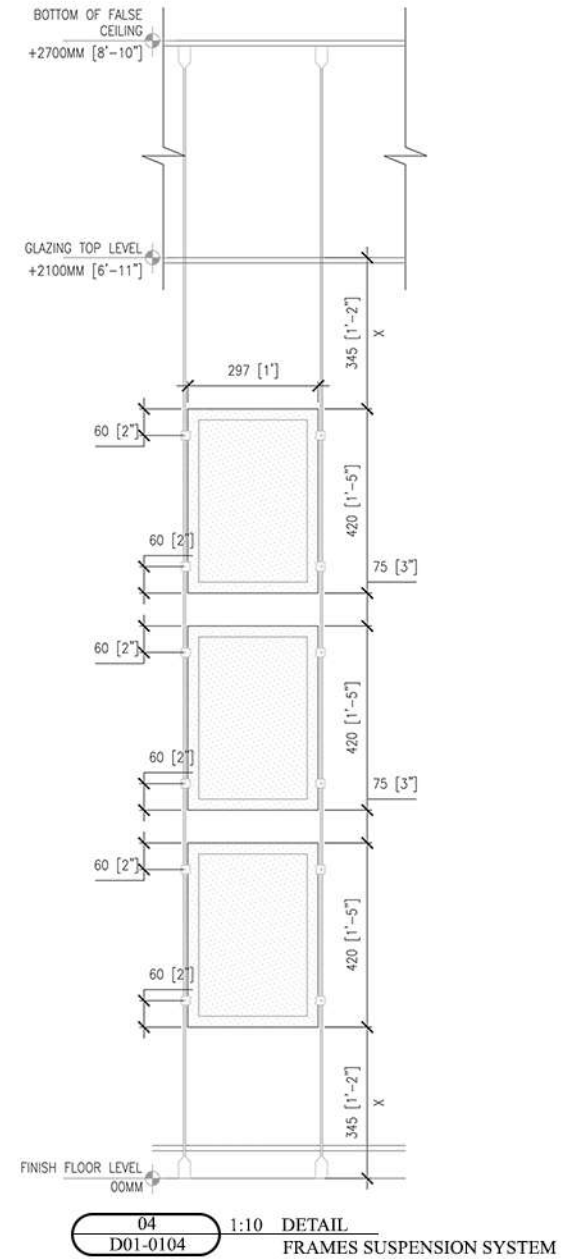
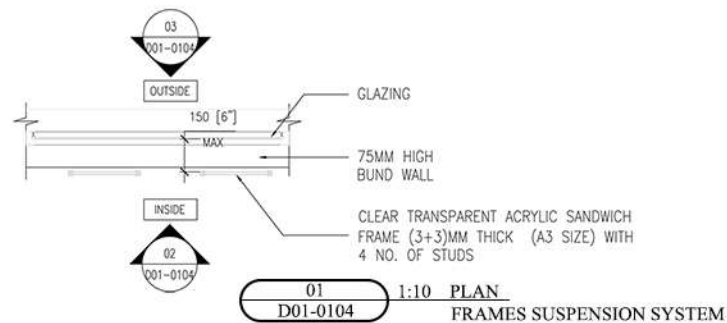
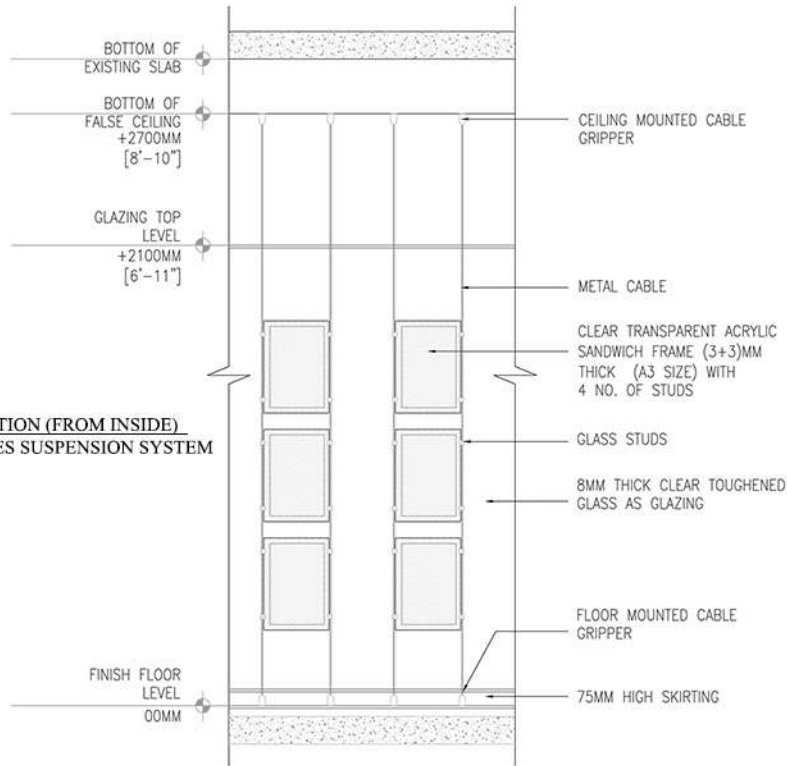

Drawings | Typical details - Placement of Equipments

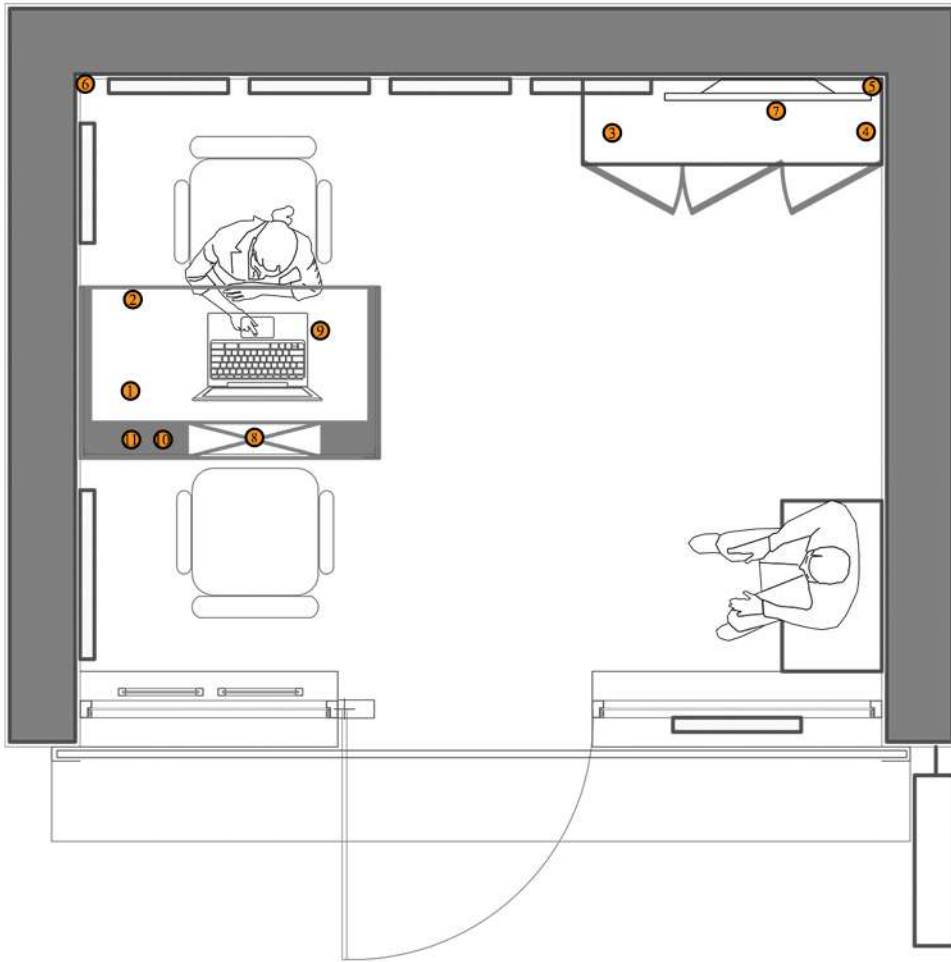

1 - PRINTER - MULTIFUNCTION



2 - SAFE



3 - CURRENCY COUNTING & FAKE NOTE DETECTOR



4 - ELECTRONIC WEIGHING SCALE



5 - NVR FOR CCTV



6 - CCTV CAMERA



7 - DIGITAL SIGNAGE



8 - DISPLAY MONITOR



9 - LAPTOP



10 - SINGLE FINGER BIOMETRIC DEVICE



11 - POS MACHINE

* Images and brand names are for reference only
 For CCTV camera location please refer to page number 18/32/47 (as per format)

material palette
and specifications

06

Material Palette and specifications

Laminate finish



NORDIC WALNUT
GREENLAM LAMINATE -
5333



OR AMERICAN WALNUT
- MERINO LAMINATES -
14538



SMOG
GREENLAM LAMINATE -
269



MISTY GREY - MERINO
LAMINATES - 21039



FROSTY WHITE
GREENLAM LAMINATE
- 113

Flooring



600 X 600 ESCARA LIGHT
GREY TILES, SOMANY



OR GRANITE GRIS MATT
KAJARJA TILES



VINYLE FLOORING - GENTLE
GREY ARMSTRONG



VINYL FLOORING - SMOKEY HILLS
- RESPONSIVE FLOORING



BLACK GRANITE

Flooring



CLASSIC IVORY, WELSPUN
FLOORING LPT - 1039354



SANDCASTLE, WELSPUN
FLOORING LPT - 1039364

Lights



2'X2' CEILING LIGHT WITH
EDISO LED AND PHILIPS
DRIVER



6" SQUARE 2C18W LED
LIGHT - SYSKA/HAVELS/
PHILIPS

Wall



PLASTIC PAINT MORNING
GLORY (0765) ASIA PAINT

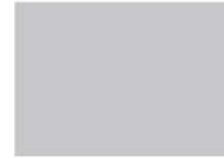

PLASTIC PAINT - COLD
FLINT (8289) ASIAN PAINT

Aluminum Finish



GREY POWDER COATED
(RAL 9004)
(OPTION 1)



NATURAL ALUMINIUM
FINISH (OPTION 2)

Ceiling



2'X2' ARMSTRONG GRID
CEILING



INDIA GYPSUM CEILING



PLASTIC PAINT MORNING
GLORY (0765)

MATERIAL SPECIFICATIONS

	Option 01	Option 02	Option 03
Commercial Plywood/boards	Century Plywood	Greenply	Anchor or any local make
Paints	Asian Paints	Dulux paint	
ACP	Alucobond	Alstrong	Alstone
Furniture Hardware	Enox	Ozone	Local make as per availability
Glass	Float glass- Modiguard, Float glass - St. Gobain	Toughened Glass is preferred in all areas Considering the safety aspect	
Rolling shutter	G.I Perforated Type finished with white synthetic enamel paint	Corrugated finished with white synthetic enamel paint	Local make as per availability
Wires	Polycab	Finolex	RR Cables
Switches/sockets	Anchor Roma	Legrand	Hevalls
MCCB/MCB	Legrand	Schneider	Siemens
DB	Legrand	Schneider	Siemens
Telephone wirt/Data/CAT 6	D-Link	POLYCAB	Legrand

The new design incorporates materials and textures that have been selected to create new experience for customers at Vakrangee Kendra.

A neutral base palette has been used which will allow durability and longevity in the design.

The combination of finishes and graphics creates authenticity and variation within the palette to allow flexibility.

- A neutral base palette allows for longvity
- The graphics are carefully chosen and created and kept light and bright for a sense of comfort

furniture overview

07

Furniture overview



1 - STORAGE : 1200 MM AS PER
DETAIL



2 - WAITING BENCH : 600 MM /
900MM AS PER DETAIL



3 - WORKSTATION (OUTSIDE) :
1200MM AS PER DETAIL



3 - WORKSTATION (INSIDE) :
1200MM AS PER DETAIL



4 - EXECUTIVE CHAIRS (OPTION 1) :
AMARDEEP/FEATHERLIE/GODREJ
OR SIMILAR MAKE
FABRIC: BLACK COLOUR



4 - EXECUTIVE CHAIRS (OPTION 2) :
AMARDEEP/FEATHERLIE/GODREJ
OR SIMILAR MAKE
FABRIC: BLACK COLOUR



5 - CUSTOMER CHAIRS (OPTION 1) :
AMARDEEP CHAIRS/FEATHERLITE/
GODREJ OR SIMILAR MAKE
FABRIC: BLACK COLOUR



5 - CUSTOMER CHAIRS (OPTION2) :
AMARDEEP CHAIRS/FEATHERLITE/
GODREJ OR SIMILAR MAKE
FABRIC: BLACK COLOUR



* Optional - Only in case of space limitations Round Stool can be used

6 - CUSTOMER CHAIRS (OPTION 1) :
AMARDEEP/FEATHERLIE/GODREJ
OR SIMILAR MAKE
FABRIC: BLACK COLOUR

6 - CUSTOMER CHAIRS (OPTION 2) :
AMARDEEP/FEATHERLIE/GODREJ
OR SIMILAR MAKE
FABRIC: BLACK COLOUR

* Images are for reference only

Marketing elements
and signage

08

Marketing element and signage

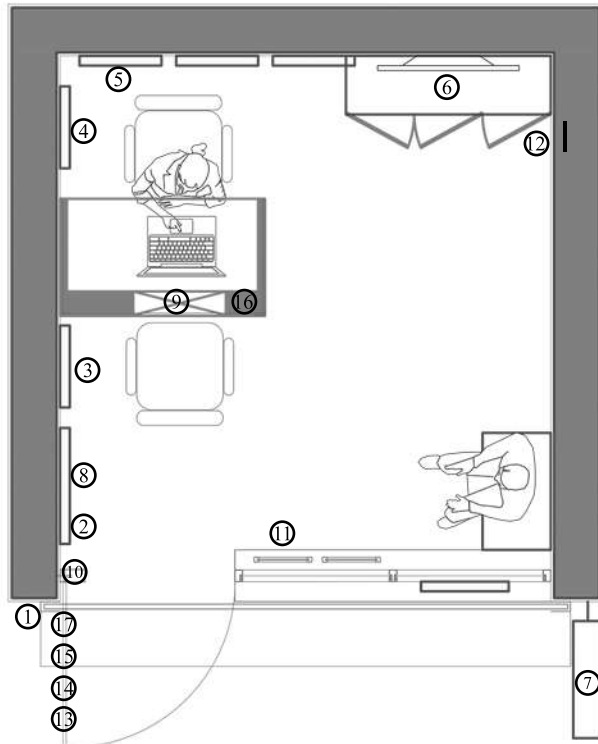

A2 size clip on frame @ 2100mm (7ft) from FFL.
 03 - For E-Commerce
 04 - For Financial Services
 05 - Marketing Panel



02 - (Dark grey fabric) A2 size soft board for BCA details and Vakrangee certificate



06 - LED Digital Signage



07- Lollipop Signage 600x600mm



08- Do's and Don'ts 210x297mm
 Printed on vinyl and pasted on 3 mm thick sunboard



12 -Franchisee Certificate 210x297mm. Certificate Artwork will be provided by Vakrangee. Black Photo frame to be procured by Franchisee.



11 - Suspended Acrylic Frames - A3 Size - For marketing from both sides



10 - Leaflet holder 525x260mm in acrylic as per drawing



13- GST Name plate - 11.693"x8.268 Vinyl sun board



15 - Covid-19 Do's and Don'ts - 16.535"x11.693 Vinyl sun board

* Images and brand names are for reference only
 For CCTV camera location please refer to page number 20/35/49 (as per format)



09 - Digital Screen



01 - Main Signage @ lintel level - length as per site. Flex Artwork will be provide by Vakrangee



14 - Push and pull sign - 5"x 5"



16 - Bank logo for Bank counter - 18"x24" Clear Vinyl Sticker



17 - 2 Nos. of Mandatory Signages - 16"x5"

Marketing element and signage

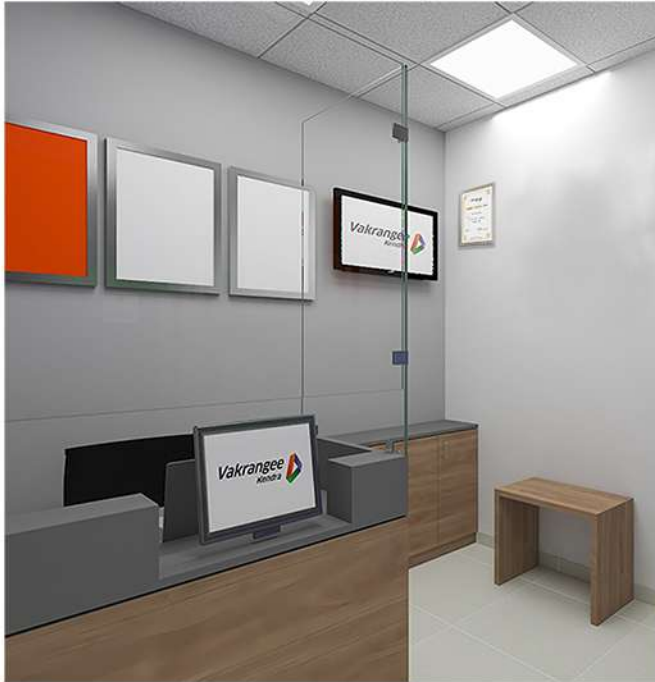

Waiting/Customer Area



Sales/Counter

Sr No.	DESCRIPTION	BRAND	STAR FLEX	LG
1	MS RECTANGULAR HOLLOW SECTION	1 INCH X 1 INCH X 18 G	ISI	
2	FLEX		SBW - 13	HI FLEX - 2
3	LAMINATION		C - 510	LP 312
4	VINYL		W - 120	LD393T
5	PRINTING	HP LATEX THIRD GENERATION		
6	PRIMER/PAINT	ISI		
7	HARDWARE	COATED	LOCAL MAKE	
8	HI BOND	INDUSTRIAL TYPE	LOCAL MAKE	
9	SUNBOARD	3 MM THICKNESS	LOCAL MAKE	
10	CLIP ON FRAME - NONLIT - A2/A3	NON-LIT - CLIP ON FRAME -37 MM WIDTH X 10 MM THICKNESS - ALUMINUM SECTION - SS OR ALUMINUM FINISH - WITH 3MM THICK WHITE SUNBOARD & 2MM THICK CLEAR POLYCARBONATE / ACRYLIC SHEET ON FRONT	LOCAL MAKE	
11	FRANCHISEE CERTIFICATE FRAME	THE CERTIFICATE PRINT TO BE FRAMED WITH 3/4TH INCH WOODEN BOX FRAME FINISHED IN BLACK COLOUR WITH A PROTECTIVE LAYER OF 2MM THICK CRYSTAL-CLEAR ACRYLIC SHEET (FOR DURABILITY OVER GLASS).	LOCAL MAKE	

* 3D renders are for reference only. Please refer drawings for detailed specifications

Check points

09

Check points | Do's and don't

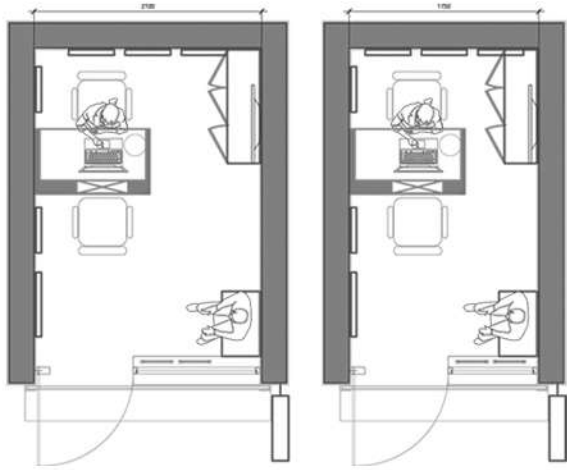

Minimum width of a Bronze Kendra

- Minimum width for any Bronze Kendra to be 1800 mm.
- Site lesser than 1800mm width shouldn't be considered
- Minimum ceiling height for any Bronze Kendra to be 2400 mm

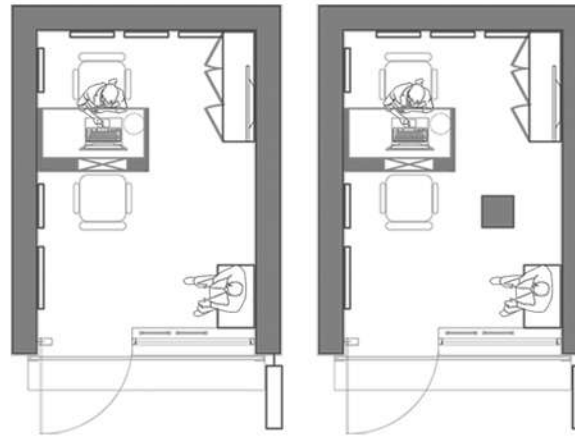

Site Selection

- Bronze Kendra site should be without columns in the middle
- Site with column or columns in the middle shouldn't be considered

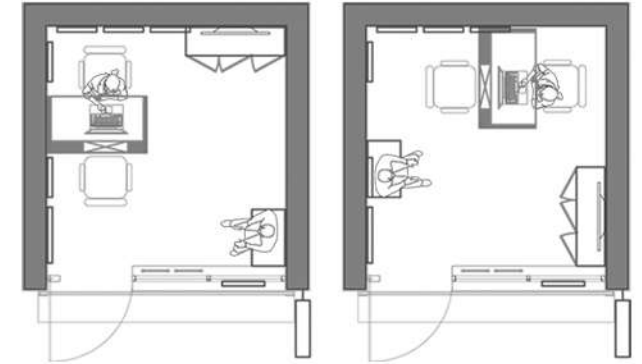

Furniture Orientation

- Franchisee to follow standard zoning diagram while designing.
- Furniture and ATM shouldn't be placed parallel to customer movement

Covid - 19 Guidelines

10

How Does COVID-19 Spread

Our design suggestions and measures are based on the world health organization (WHO) research on the spread of COVID-19

- People can catch COVID-19 from others who have been infected by virus. The disease can spread from person to person through small droplets from the nose or mouth which are spread when a person with COVID-19 coughs or exhales.

Design measure: Shielding

- These droplets land on objects and surfaces around the person. Other people then catch COVID-19 by touching these objects or surfaces, then touching their eyes, nose or mouth

Operational measure: Sanitization

- People can also catch covid-19 if they breathe in droplets from a person with covid-19 who coughs out or exhales droplets. This is why it is important to stay more than 1.8 meter (6 feet) away from a person who is sick.

Planning measure: Social distancing

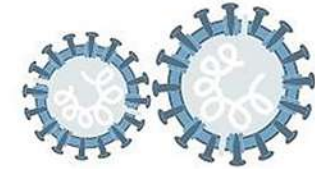
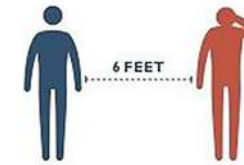

The virus usually spreads from **CLOSE PERSON-TO-PERSON CONTACT** through respiratory droplets from coughing and sneezing.

The virus may also spread **THROUGH AIRBORNE TRANSMISSION**, when tiny droplets remain in the air even after the ill person leaves the area.

...but it can also be left on objects and surfaces.



Pens



Lift buttons



Keyboard & mouse



Doorknobs



Touch-screens devices



Kitchen surfaces

So if you touch something contaminated and then shake hands or hug another person, you will transmit the virus.



Measures:

1. Thermal Screening: Thermal Screening at the entry for staff members and customers

2. Masks & Gloves: Hand over masks or PPE to staff and customers entering the kendra. Provide antibacterial gloves to team members especially if they handle cash/parcels.

3. Hand Sanitisation: Hand wash with soap or hand sanitiser stations at strategic locations. It is recommended to install automated hand wash with soap / hand sanitiser units

4. Shield: Install antibacterial screens on counters to protect customer and team members

5. Entrance Matting: Place mats at the entrance that could be dipped in 1% sodium hypochlorite (change 2 hours) to ensure the footwear is clean

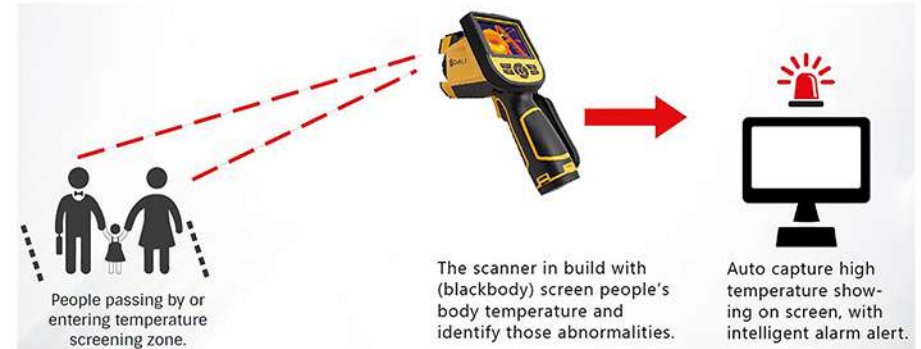

6. Temporary Partitions: Install temporary antibacterial partitions for social distancing or to restrict customer movement.

7. Social Distancing: Frenchie's to encourage social distancing within the kendra using floor decals, marketing posters at strategic locations and in addition, train all the staff members to follow and implement social distancing

8. MEP Guidelines: Update MEP guidelines for Frenchie's to manage the kendra. Clean water tanks and AC system before starting the kendra post the lockdown.



Thermal Screening



Body temperature must be measured before the Staff and Customers enter the Vakrangee Kendra.

Any abnormality to be recorded and reported to local health officials.

Mask and Gloves



Mask

When and how to wear masks to protect against coronavirus

- Before putting on a mask, clean hands with alcohol-based hand rub or soap and water.
- Cover mouth and nose with mask and make sure there are no gaps between your face and the mask.
- Avoid touching the mask while using it, if you do, clean your hands with alcohol-based hand rub or soap and water
- Replace the mask with a new one as soon as it is damp and do not re-use single-use masks.
- To remove the mask : remove it from behind (do not touch the front of mask); discard immediately in a closed bin; clean hands with alcohol-based hand rub or soap and water.

Gloves

Provide antibacterial gloves to team members especially if they handle Cash / Parcels

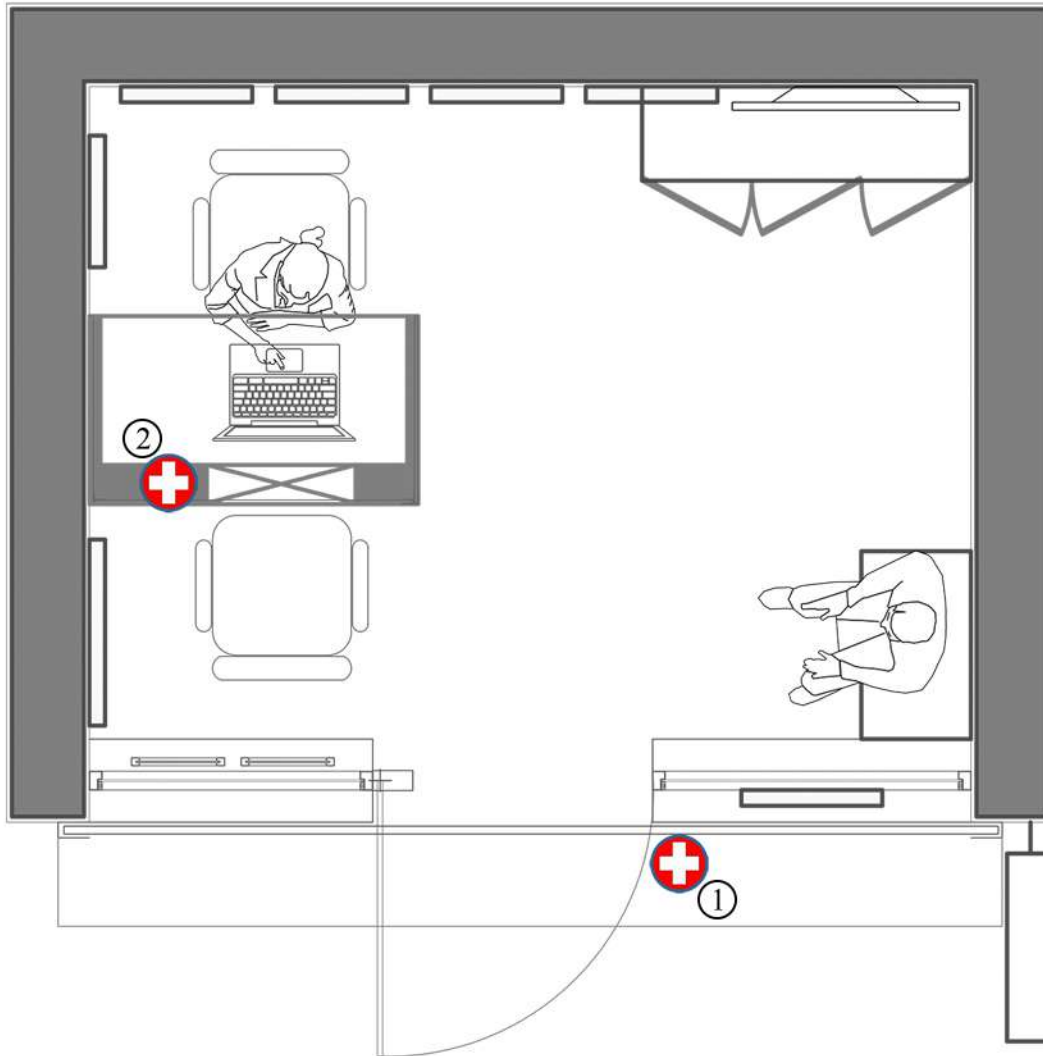

SANITIZING STATION

1. Outside of Entrance Door
2. On counter Table

Is hand sanitizer effective against COVID-19 ?

Ans. The best way to prevent the spread of infections and decrease the risk of getting sick is by washing your hands with plain soap and water, advises the **Ministry of Health and Family Welfare (MoHFW)**.

Washing hands Often with soap and water for at least 20 seconds is essential, especially after going to the bathroom; before eating; and after coughing, sneezing, or blowing one's nose. If soap and water are not available, **MoHFW** recommends consumers use an alcohol-based hand sanitizer that contains at least 65% alcohol

Reference: World Health Organisation / Ministry of Health and Family welfare

Case Study



Case Study



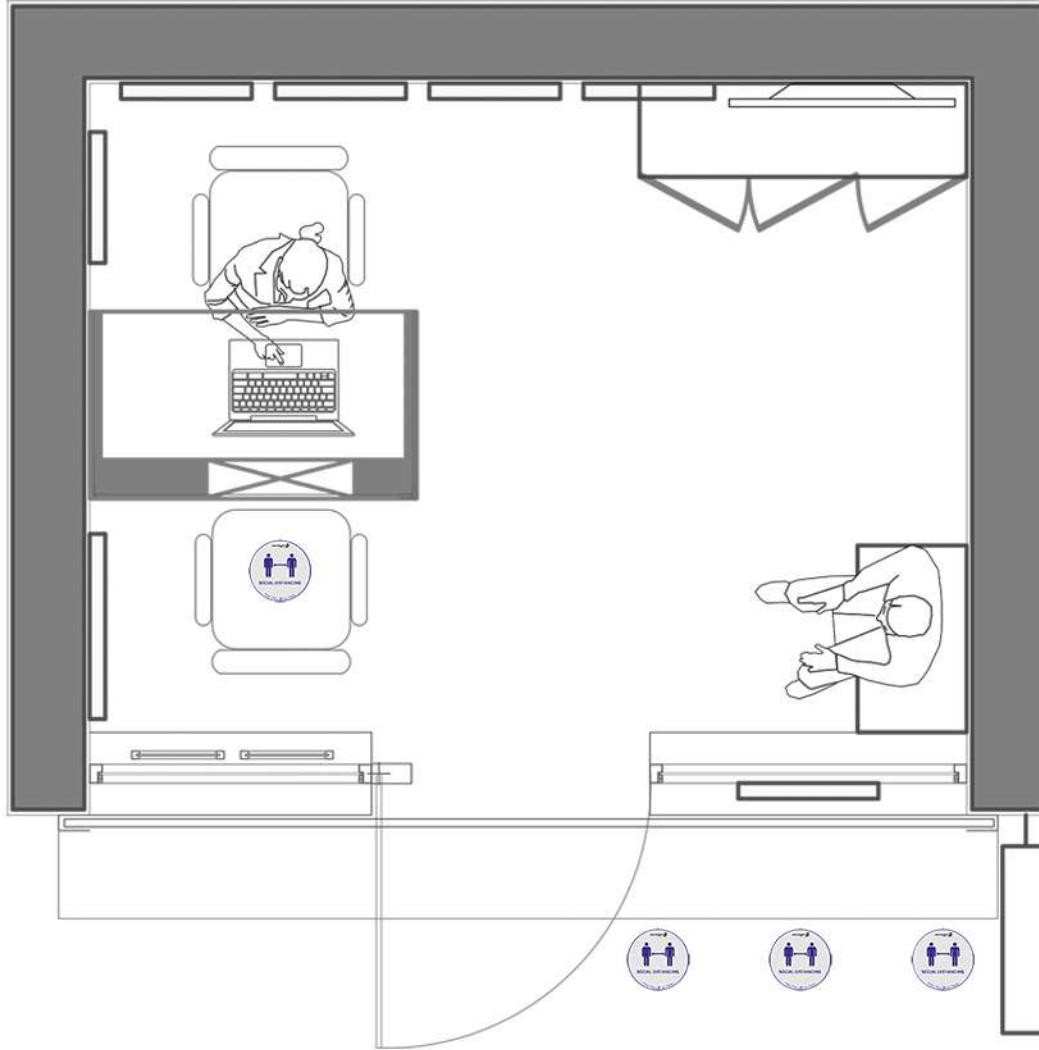

SOCIAL DISTANCING

- Please Keep minimum 6 Feet distance.
- Do not shake hands with anyone
- Avoid touching door handles.
- Always wear mask
- Observe discipline

Reference: World Health Organisation / Ministry of Health and Family welfare

Case Study



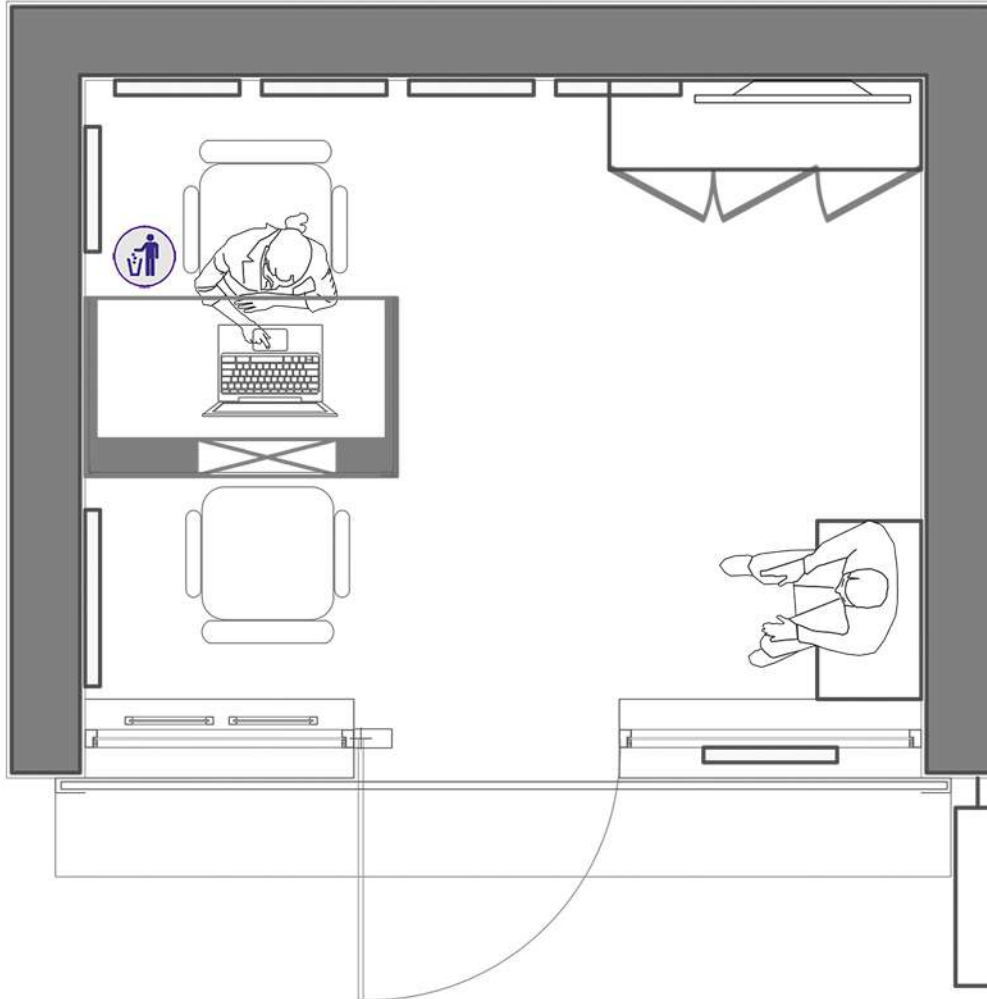

DUSTBIN

1. Near Counter Table

- Please throw used mask and gloves into the Dustbin
- Keep the Dustbin lid close all the time
- Disinfect dustbin daily
- Destroy the Dustbin contents daily
- Use foot operated Dustbin and avoid touching with hand

Reference: World Health Organisation / Ministry of Health and Family welfare

Case Study



Do's and Don'ts



Protect yourself and others! Follow these Do's and Don'ts

Do's ✓



Practice frequent hand washing. Wash hands with soap and water or use alcohol based hand rub. Wash hands even if they are visibly clean



Cover your nose and mouth with handkerchief/tissue while sneezing and coughing



Throw used tissues into closed bins immediately after use



See a doctor if you feel unwell (fever, difficult breathing and cough). While visiting doctor wear a mask/cloth to cover your mouth and nose



If you have these signs/symptoms please call State helpline number or Ministry of Health & Family Welfare's 24X7 helpline at 011-23978046



Avoid participating in large gatherings



Have a close contact with anyone, if you're experiencing cough and fever



Touch your eyes, nose and mouth



Spit in public

Don'ts ✗

Together we can fight Coronavirus

For further information :

Call at Ministry of Health, Govt. of India's 24X7 control room number

+91-11-2397 8046

Email at ncov2019@gmail.com

dsvp-171021300211920

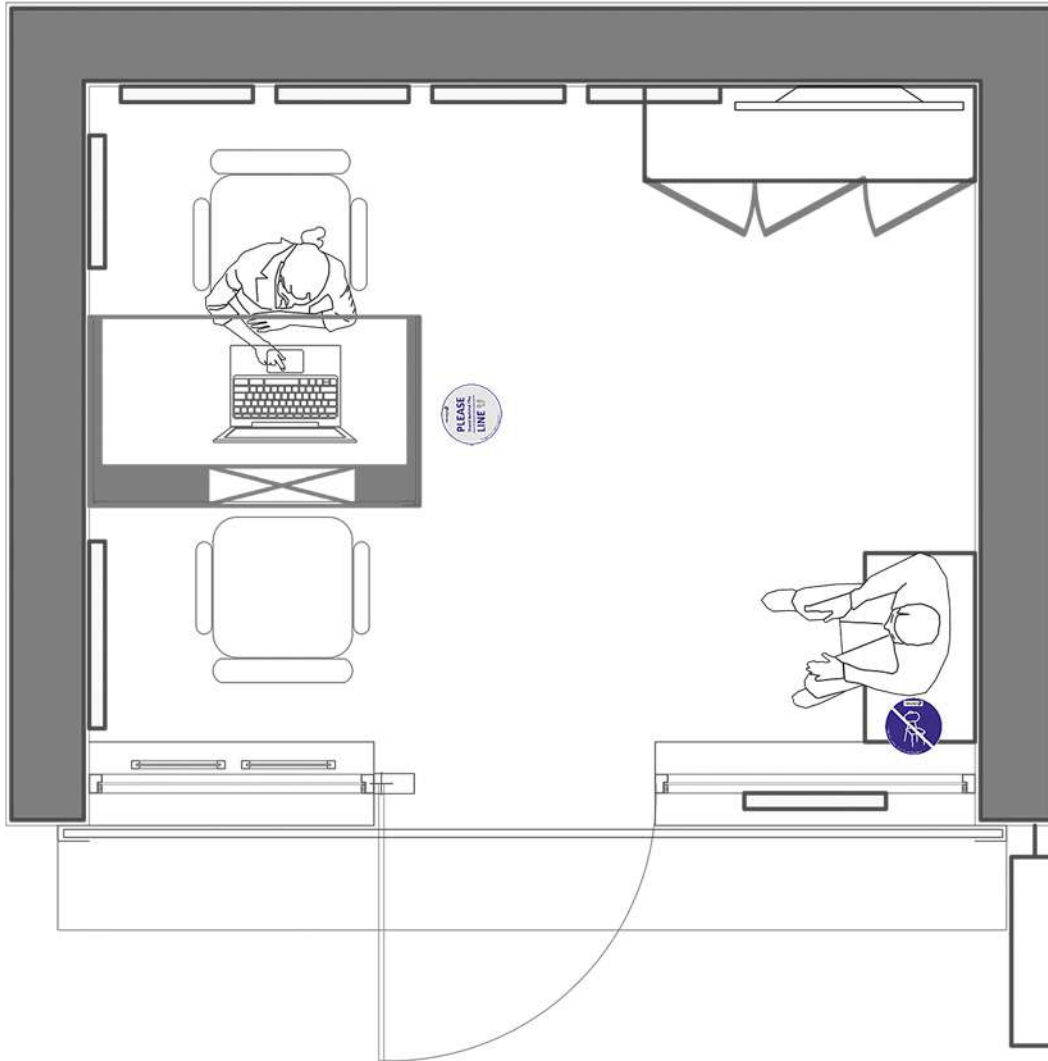

LEAVE SEAT EMPTY



PLEASE STAND BEHIND THE LINE

- Keep minimum distance of 6 Feet between other person while seating on waiting bench
- Please Stand behind the line. Keep minimum distance of 6 Feet

Reference: World Health Organisation / Ministry of Health and Family welfare

Case Study

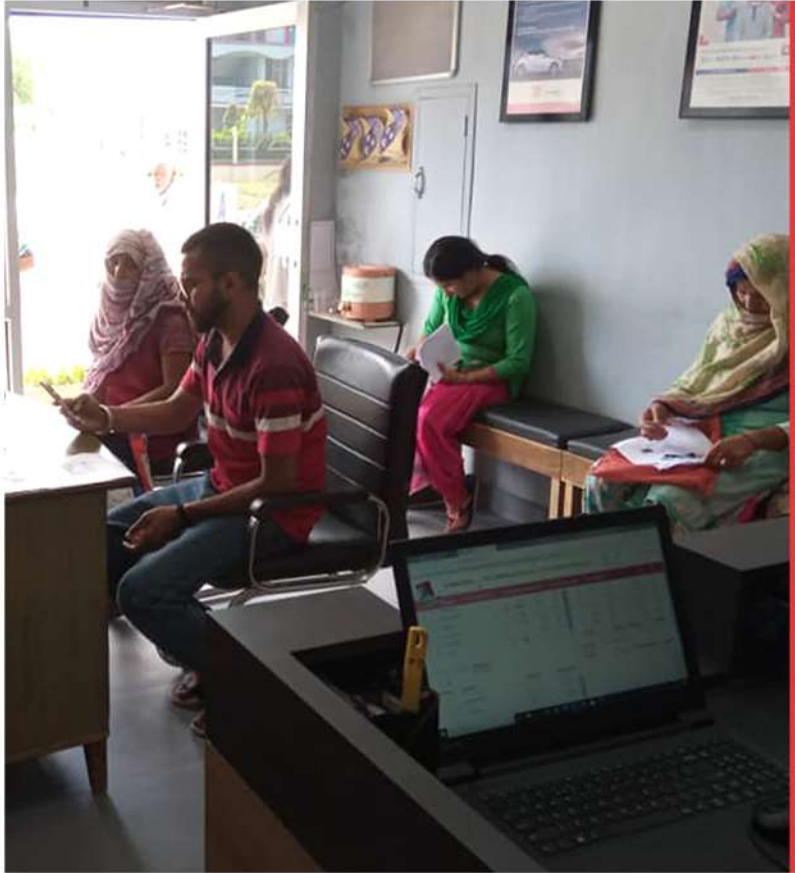

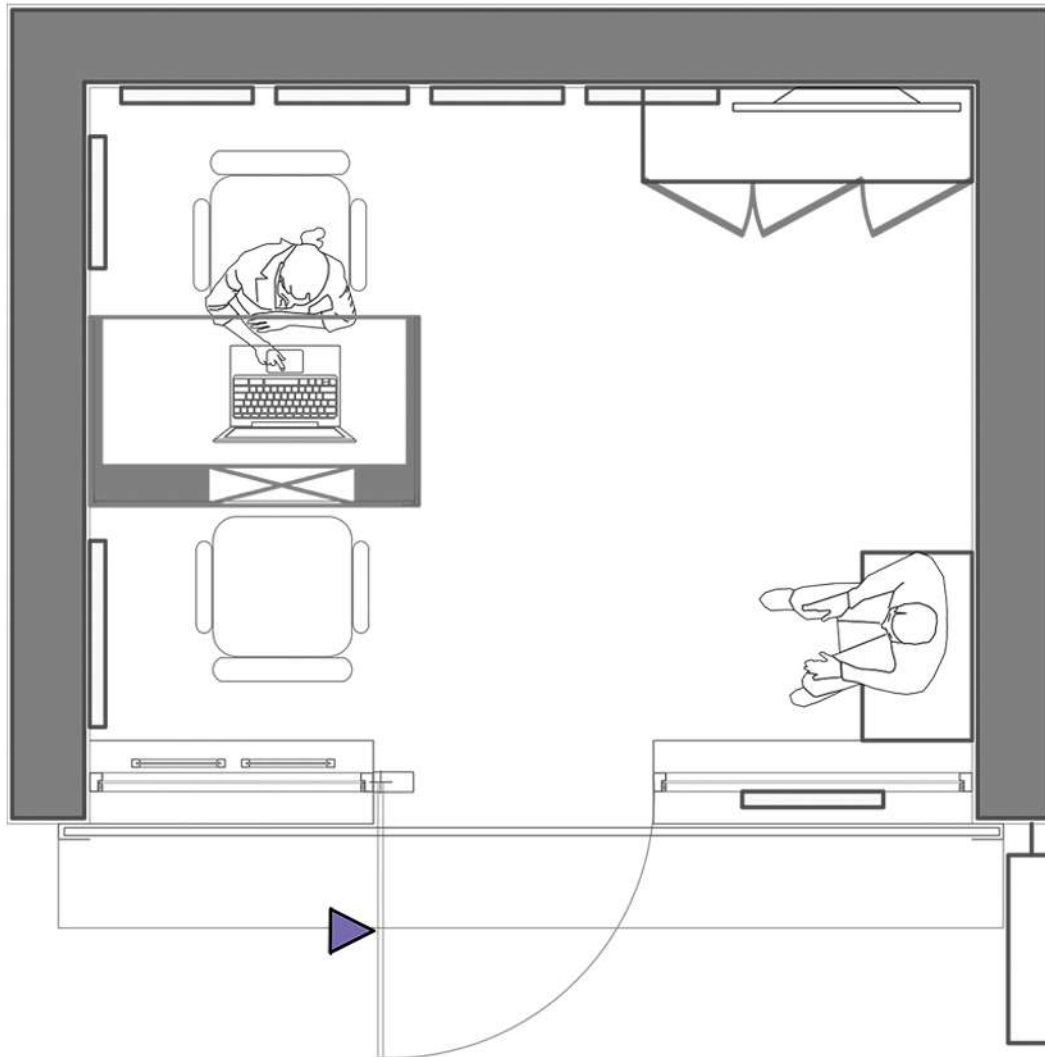

GENERAL INSTRUCTIONS

GENERAL INSTRUCTIONS FOR FRANCHISEE & CUSTOMER

- 1 - Wearing of Mask is compulsory
- 2 - Use sanitizers before entering and at the time of exit.
- 3 - Throw used Mask and Hand Gloves into the Dustbins
- 4 - Keep social distance of minimum 6 Feet inside and outside of Kendra
- 5 - Download Arogya Setu Mobile App
- 6 - Wash entrance Door mat with 1% sodium hypochlorite every 4 hours.
- 7 - Disinfect whole Kendra by 1% sodium hypochlorite every 4 hours.

(To be placed in the suspended Acrylic frames from inside the Kendra in place of one of the money transfer poster on A3 portrait size paper)

Reference: World Health Organisation / Ministry of Health and Family welfare

Maintenance Guidelines - For Kendra Interior and Branding Elements.

Franchisees are advised to follow the Maintenance Guidelines for ensuring intended life of the elements and also to keep them in good order and conditions

1. Main Sign Board:

- 1-Once in a month Clean with Mild Soap water using soft cloth.
- 2- In case of Bird shit or any other issue clean immediately with mild soap and water.

2. Vinyle / Sunboard Posters:

- 1- Once in Fortnight clean with mild soap water using soft cloth. Do not use brush or coarse material.
- 2- If corners are lifted up or become loose then use feviquick or any instant adhesives to fix it immediately.

3. Clip on Frames/ Acrylic Hanging frames.

- 1- Check fixing screws and tighten if it is loose.
- 2- Clean the frames with mild soap water using soft cloth.

4. Leaflet Holder:

Wipe with soft cloth as and when required. Do not use force.

5. Floor Mat/Vitrified Tiles:

Weekly cleaning using mild soap water or as and when required.

6. Wall Paint:

Monthly cleaning with soft wet cloth in case of Distemper or Oil paint.

7. Wooden Furniture:

Monthly cleaning with dry or wet soft cloth.

8. Door Glass /Counter table Glass:

Clean Glass regularly using glass cleaning liquid.

9. LED lights:

Regular cleaning with soft wet cloth.

10. Door Mat:

Regular cleaning by dipping in 1% Sodium Hypochlorite.

11. Chairs/ Waiting Bench:

Regular cleaning with soft wet cloth.

12. Dustbin:

- 1- Destroy contents of the Dustbin daily.
- 2- Use plastic Dustbin bags.
- 3- Wash daily with Dettol water or use disinfectants.

Advisable:

- 1- Disinfect daily whole Kendra using approved disinfectants.
- 2- Do regular pest control of Kendra.

**For any Technical queries regarding Design Manual
Please Contact**

Name	Contact No.	Email id
Mr. Nishant Jadhav	7045996119	nishant.jadhav@vakrangee.in
Mr. Dhaval Joshi	8879047379	dhavalj@vakrangee.in
Mr. Jitendra Pawar	8291635061	jitendra.pawar@vakrangee.in

Vakrangee Limited

Vakrangee Corporate House, Plot No.93, Road No.16,
MIDC Marol, Andheri (East), Mumbai - 400 093.
Telephone No. +91 22 67765100
www.vakrangee.in

Thank You

| www.vakrangee.in |